

3D- 4GAS - NO TIMER CONTROL PANEL ASSEMBLY

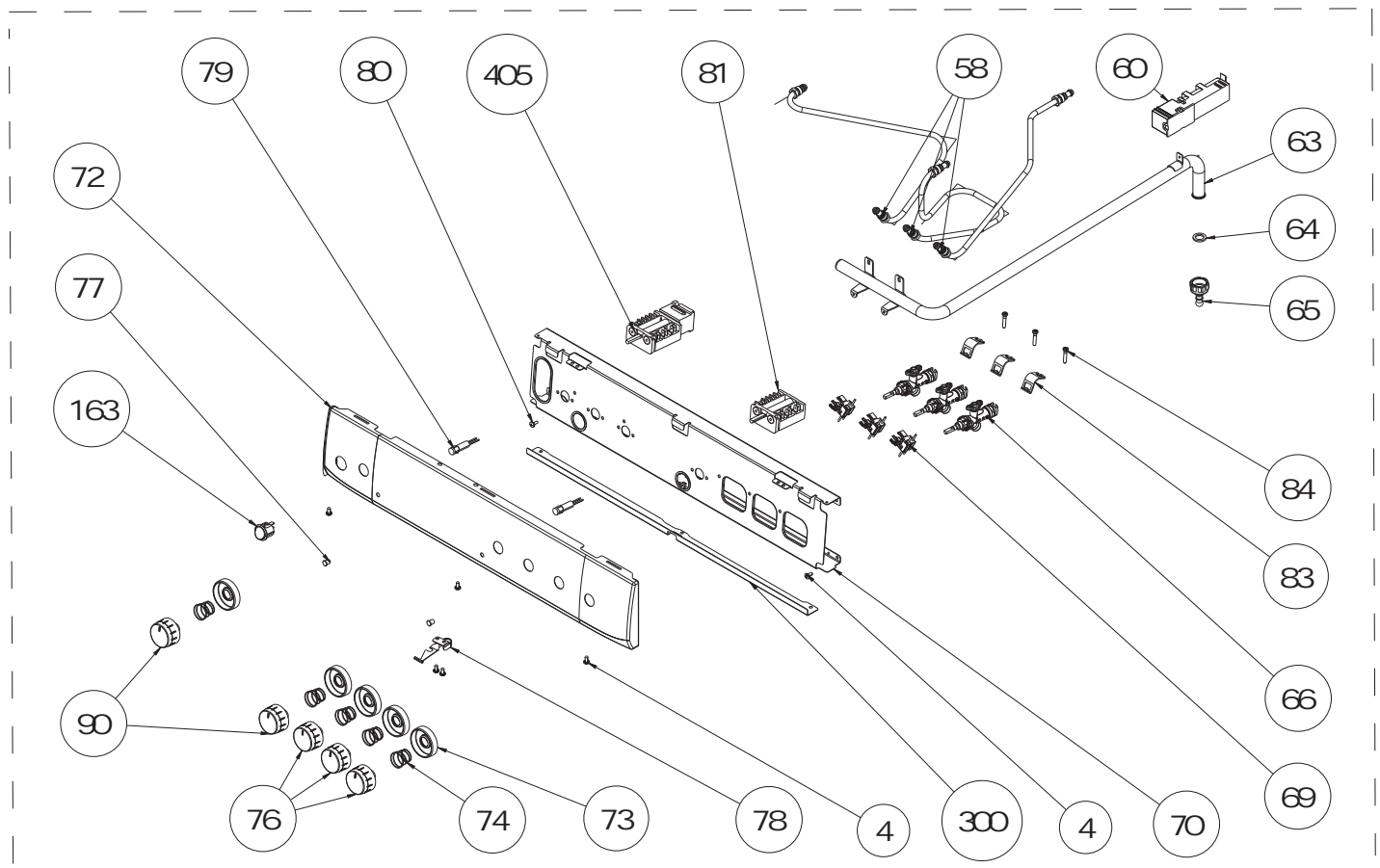

3D- 3GAS+1ELECTRIC - NO TIMER CONTROL PANEL ASSEMBLY

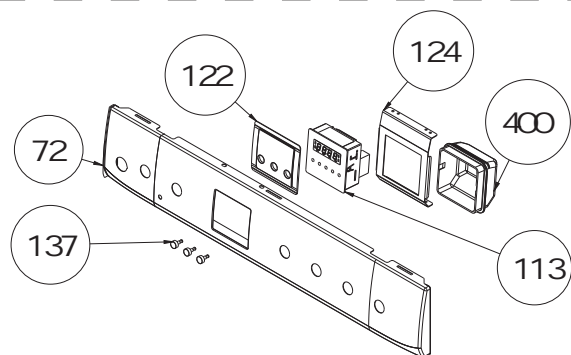

DIGITAL TIMER (OPTIONAL)

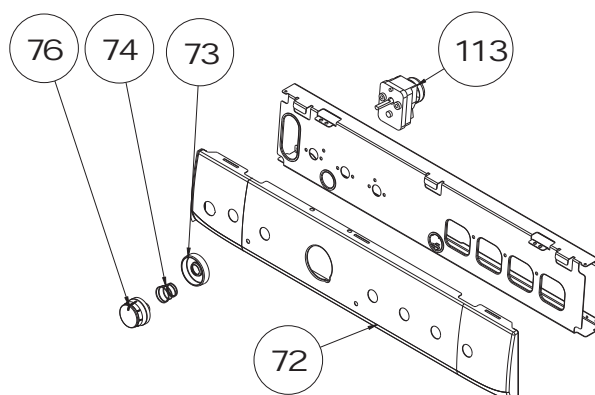

MECHANIC TIMER (OPTIONAL)

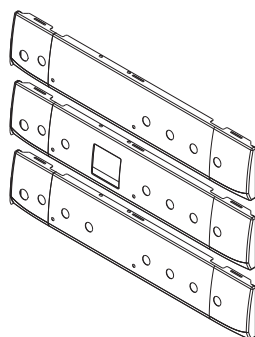

3D METAL CONTROL PANELS
(OPTIONAL)

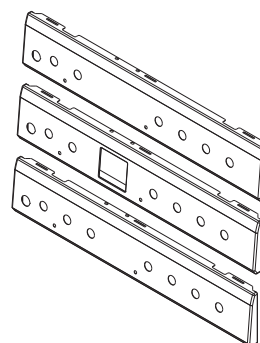

FLAT METAL CONTROL PANELS
(OPTIONAL)

CONTROL PANEL ASSEMBLY PARTS

POSITION NUMBER	PART NAME
4	SCREW (3.9*9.5)
58	GAS DELIVERY TUBE
60	IGNITOR (4 OUTLET)
63	MANIFOLD (66, 4G, REGULAR)
64	STRAIGHT HOSE FITTING GASKET
65	HOSE FITTING (NG)
66	COOKTOP VALVE
69	MICROSWITCH HARNESS
70	INNER PANEL
72	FRONT PANEL GROP (GLASS / METAL)
73	KNOB RING
74	KNOB SPRING
76	KNOB (GAS)
77	SIGNAL LAMP LENS
78	CHILD LOCK
79	SIGNAL LAMP BODY
80	SCREW (M 4*6)
81	FUNCTION SELECTOR SWITCH / HOTPLATE SWITCH
82	CAPILLARY THERMOSTAT
83	COOKTOP VALVE ASSEMBLY BRACKE
84	SCREW (M 4*18, HEAD Ø9)
90	KNOB - ELECTRICAL
113	TIMER (MECHANIC / DIGITAL / ANALOG)
122	TIMER LENS
124	TIMER HOLDER (DIGITAL / ANALOG)
137	TIMER BUTTON
163	OVEN LIGHT BUTTON
188	ENERGY REGULATOR
300	KNIFE BARRIER, SUBPANEL (NEW G)
400	DIJITAL TIMER COVER PLASTIC (NEW GEN)

"The exploded views given in this document are generic. They include all possible versions of the product.

For specific part codes, please refer to the bom list of regarding model."

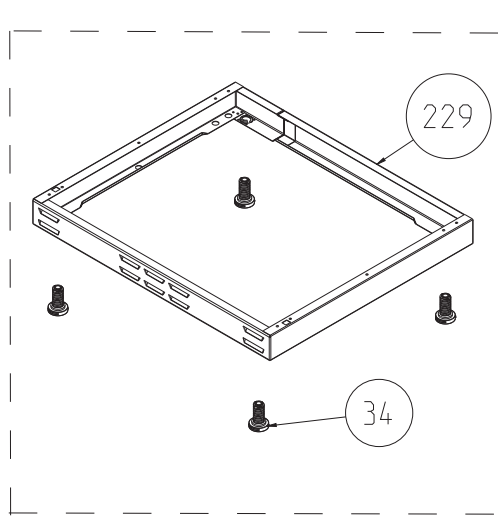

**EXTRA BOTTOM SUPPORT
(WITH LOUVRES)**

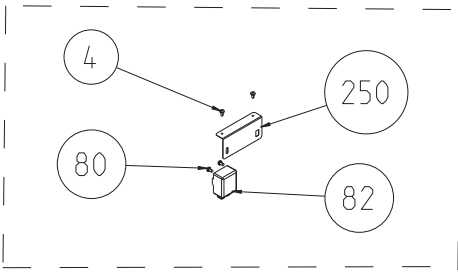

**(OPTIONAL ONLY FOR
ELECTRIC GRILL FS GAS)**

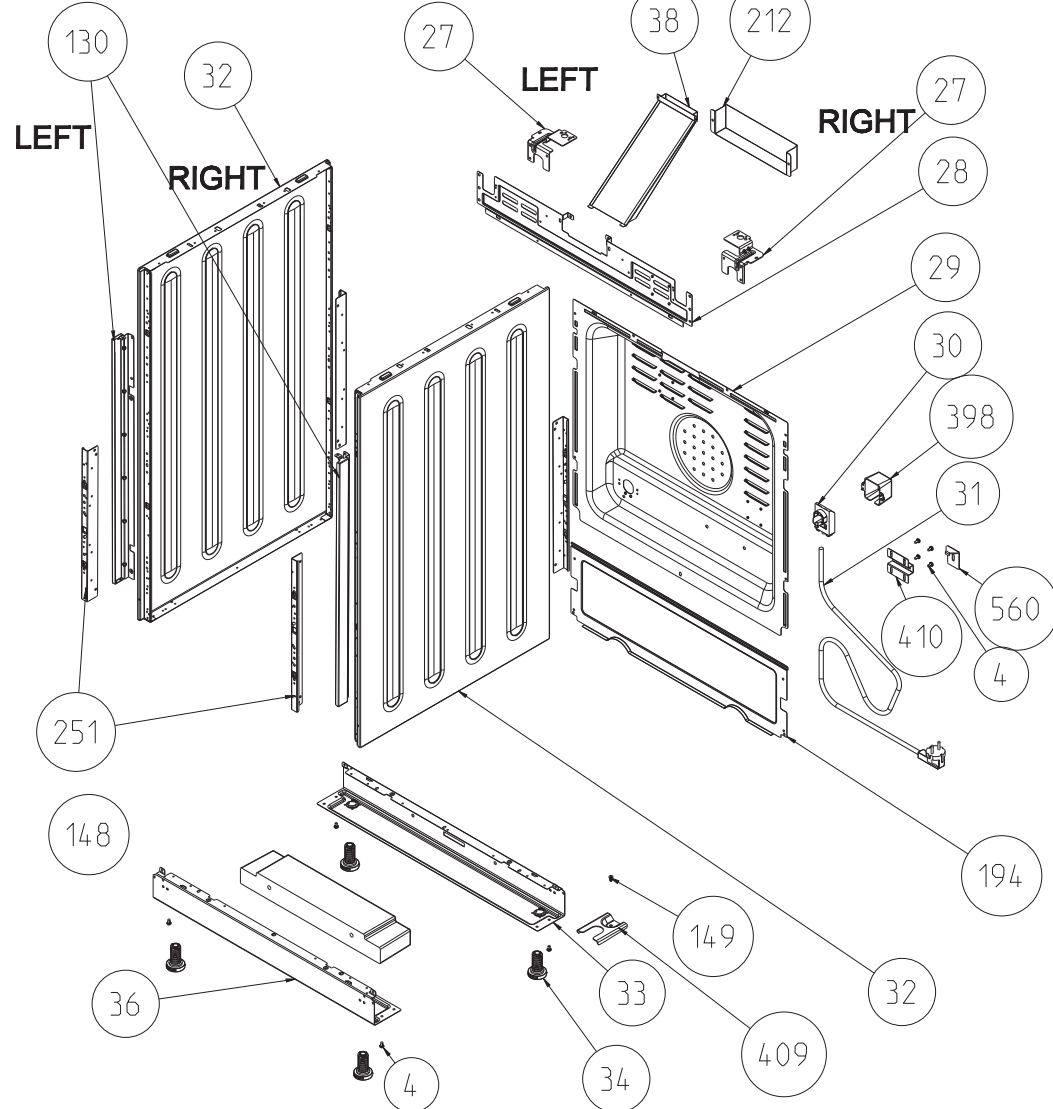

SIDE PANEL ASSEMBLY	
POSITION NUMBER	PART NAME
4	SCREW (3.9*9.5)
27	COOKTOP ANGLE IRON (LEFT / RIGHT)
28	REAR TOP PANEL
29	REAR PANEL
30	TERMINAL BOX
31	POWER CORD
32	SIDE PANEL
33	REAR PLINTH
34	ADJUSTABLE FOOT
36	FRONT PLINTH
38	EXHAUST (56/66)
80	SCREW (KNURLED, M4*6)
82	CAPILLARY THERMOSTAT
130	SIDE CLOSING PROFILE (FOR FLAT OVEN DOOR WITH FULL GLASS)
148	CONCRETE WEIGHT
149	SCREW (CIRCULAR-HEAD, 4.8*32)
194	REAR BOTTOM LID (OPTIONAL)
212	EXHAUST PROTECTION COVER (NEW G.)
229	EXTRA BOTTOM SUPPORT (ONLY FOR 90CM)
250	GAS-ON-GLASS HOB IGNITOR HOLDER
251	SIDE PANEL SUPPORT BRACKET
398	TERMINAL BOX COVER PLASTIC (66,56,GAS)
409	ANTI-TIP BRACKET (GROUND TYPE)
410	ANTI-TIP BRACKET HOLDER (WALL TYPE)
560	ANTI-TIP BRACKET (WALL TYPE)

"The exploded views given in this document are generic. They include all possible versions of the product. For specific part codes, please refer to the bom list of regarding model."

OVEN DOOR HANDLES (OPTIONAL)
HANDLES WITHOUT TAP & BRACKET

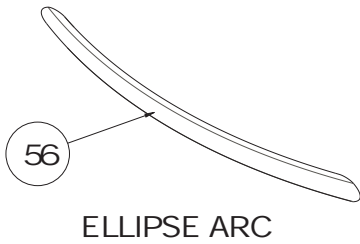

ELLIPSE ARC

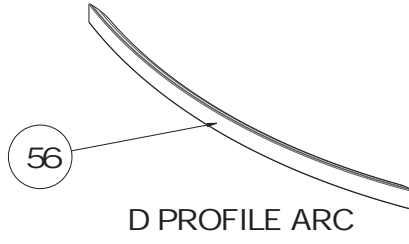

D PROFILE ARC

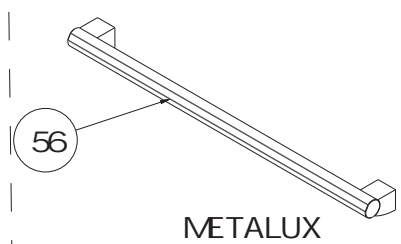

METALUX

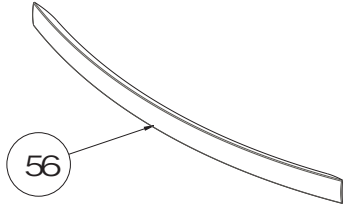

D PROFILE ARC, ELECTROLUX
(ONLY FOR FS - OPTIONAL)

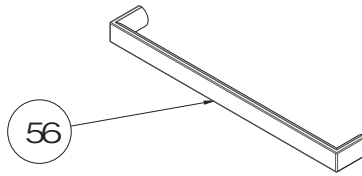

FNP (ONLY FOR BUILT-IN -
OPTIONAL)

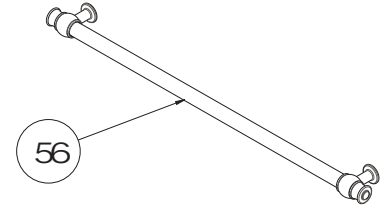

RUSTIC

HANDLES WITH BRACKET

HANDLES WITH TUNNEL TAP

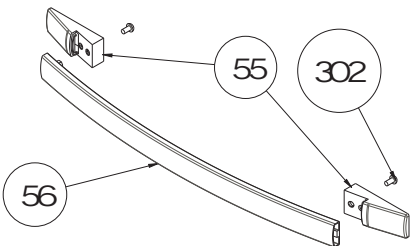

ARC QUADRANGLE

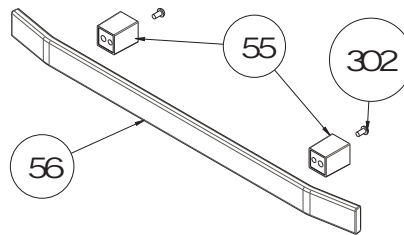

3D QUADRANGLE (ONLY FOR
FS/NEWG/BUILT-IN - OPTIONAL)

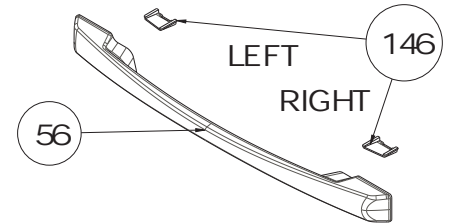

NO FAN TYPE (ONLY FOR
BUILT-IN - OPTIONAL)

HANDLES WITH TAP & BRACKET

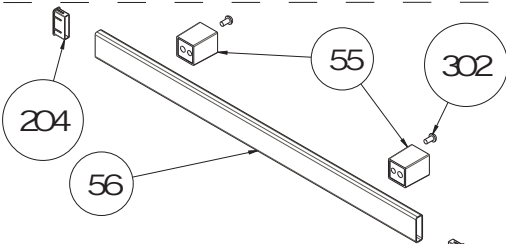

FLAT QUADRANGLE
(ONLY FOR FS/NEWG/BUILT-IN - OPTIONAL)

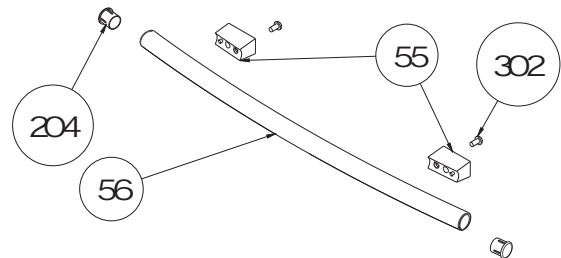

ARC TUBE

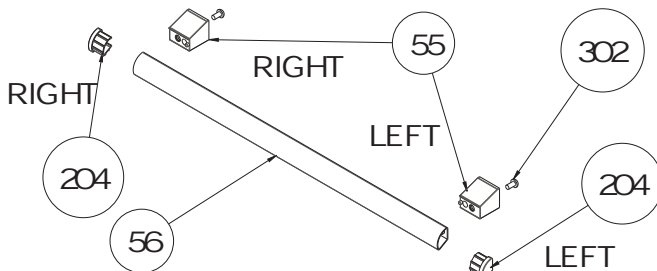

FLAT SLICE

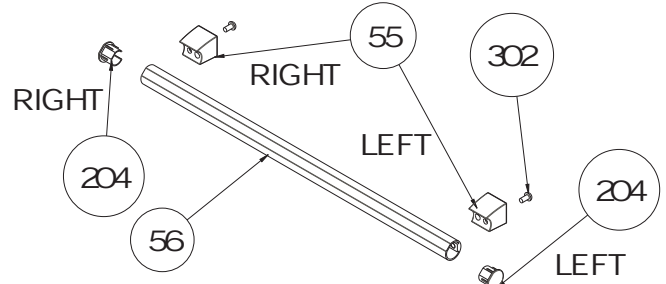

TRIO

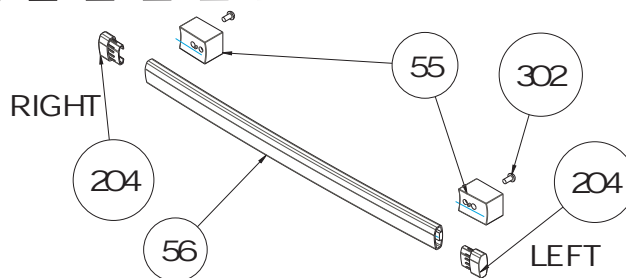

CURVED QUADRANGLE

KNOBS (ONLY FOR NEWG - OPTIONAL)

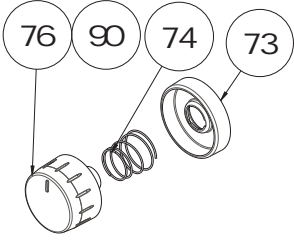

OMEGA

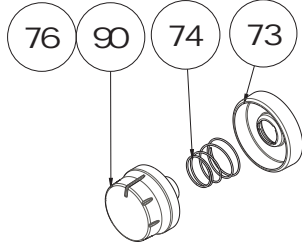

EPSILON

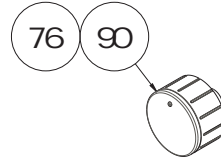

BIG MACRO
(ONLY FOR NEWG ELECTRIC/
NEWG VITROCERAMC - OPTIONAL)

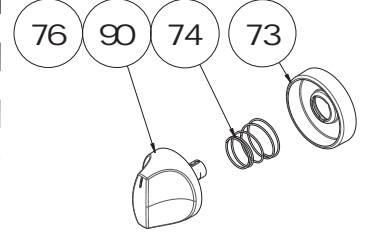

GAMA RING

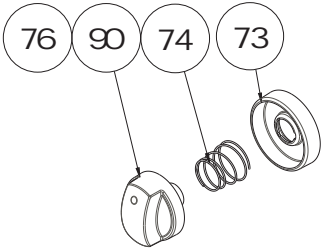

ECLIPSE RING

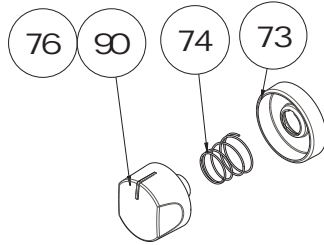

RIND

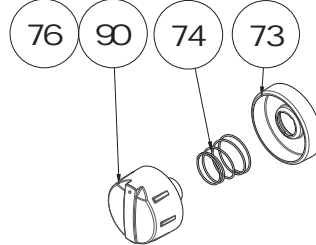

ANTERO

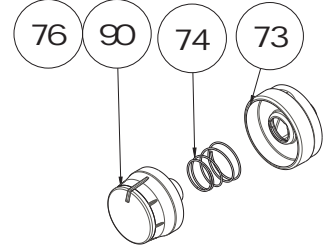

SPECTRUM

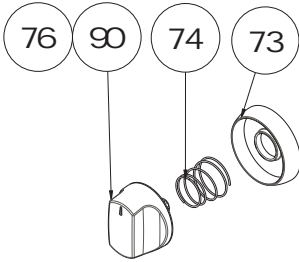

TRIO

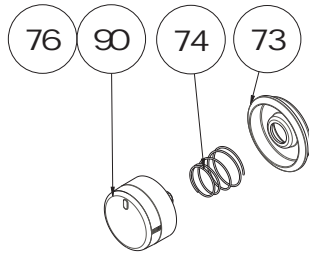

SIGMA

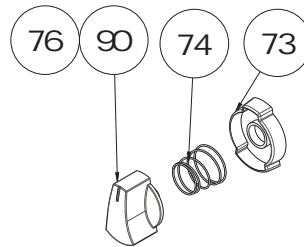

DELTA RING

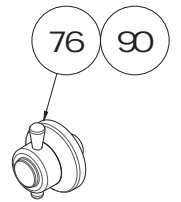

RUSTIC RISUS