

### CONTROL PANEL ASSEMBLY

POSITION NUMBER	PART NAME
4	SCREW (3.9*9.5)
70	INNER PANEL
71	SCREW (KNURLED, 3.9*6.5)
72	FRONT PANEL GROP (GLASS / METAL)
73	KNOB RING
74	KNOB SPRING
77	SIGNAL LAMP LENS
78	CHILD LOCK
79	SIGNAL LAMP BODY
80	SCREW (M4*6)
81	FUNCTION SELECTOR SWITCH / HOTPLATE SWITCH
82	CAPILLARY THERMOSTAT
90	KNOB - ELECTRICAL
113	TIMER (MECHANIC / DIGITAL / ANALOG)
122	TIMER LENS
124	TIMER HOLDER (DIGITAL / ANALOG)
137	TIMER BUTTON
188	ENERGY REGULATOR
300	KNIFE BARRIER
400	DIJITAL TIMER COVER PLASTIC(NEW GEN)

"The exploded views given in this document are generic. They include all possible versions of the product. For specific part codes, please refer to the bom list of regarding model."

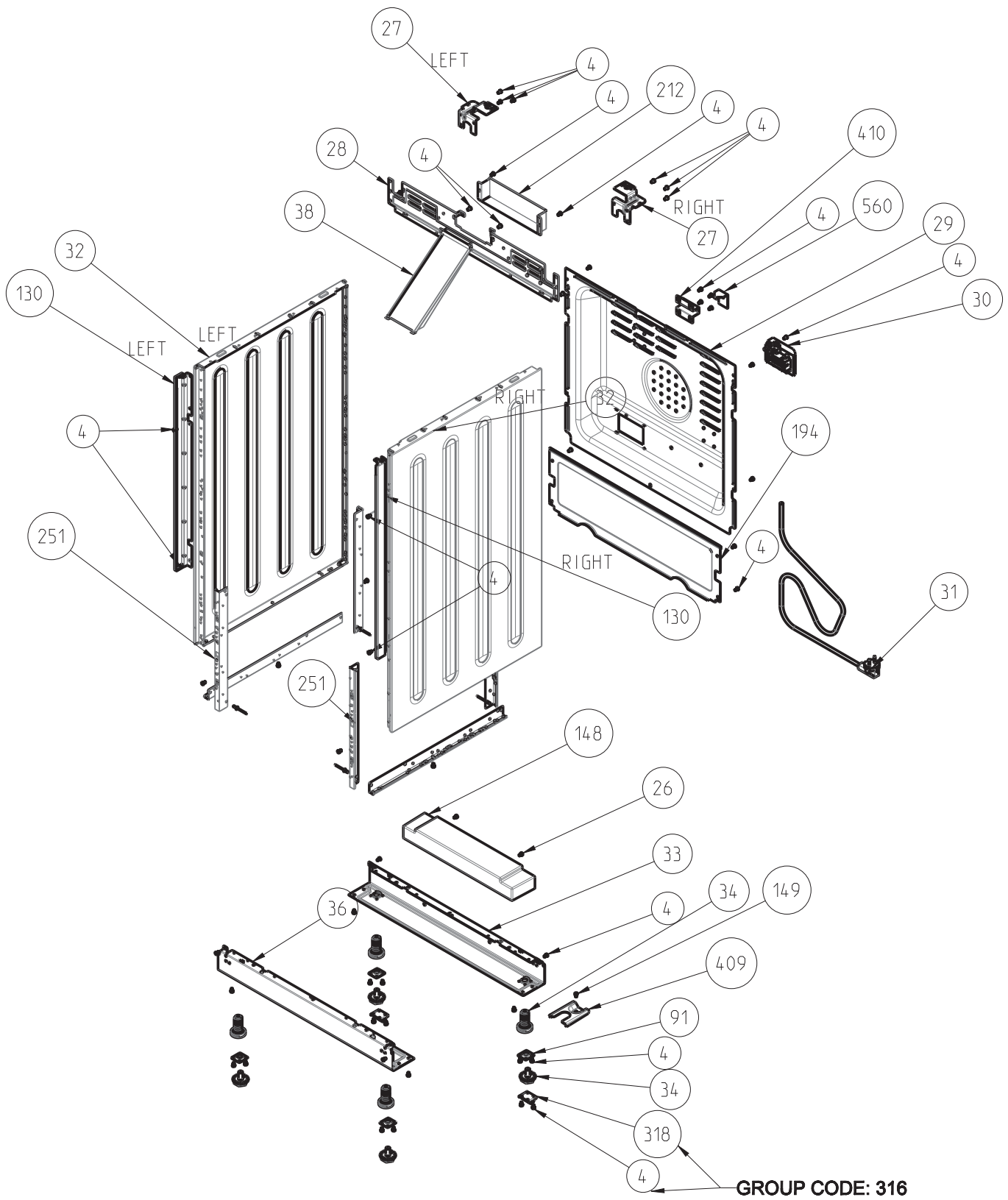

YNTB 85 CM SIDE PANEL ASSEMBLY

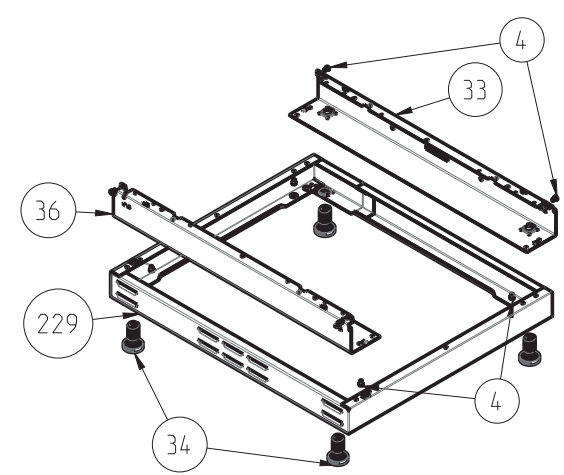
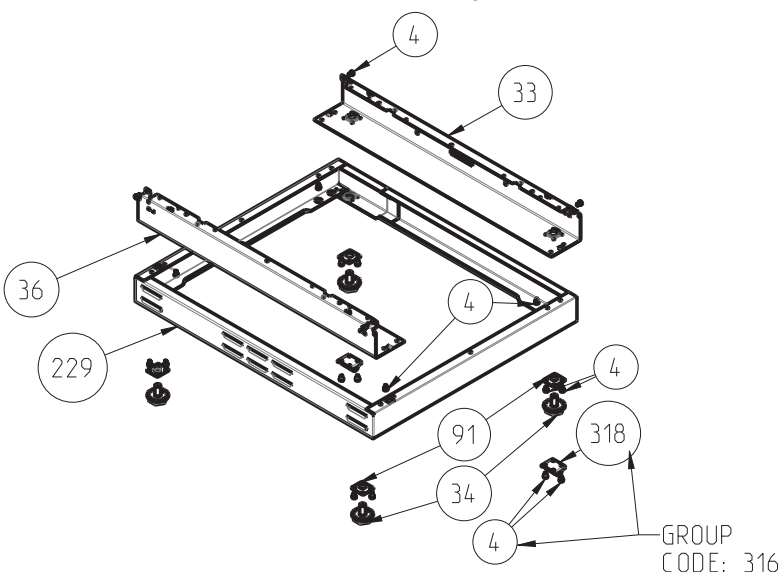
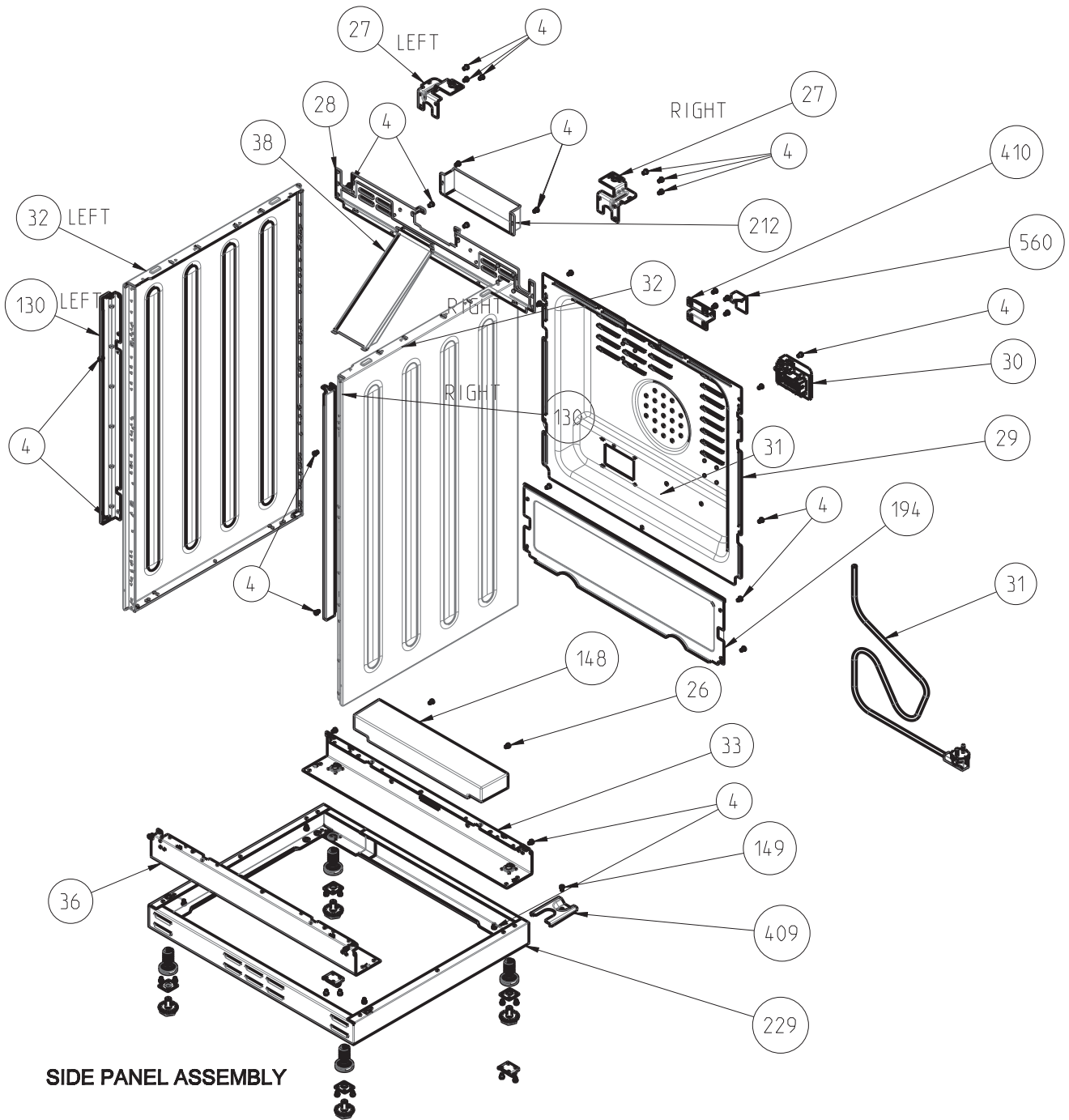

POSITION NUMBER	PART NAME
4	SCREW(CONEHEADED,3.9x9.5 )
26	SCREW (CIRCULAR-HEAD,4.2*32)
27	CHASSIS BRACKET
28	REAR TOP PANEL
29	REAR PANEL
30	TERMINAL BOX -16A - 400V
31	POWER CORD
32	SIDE PANEL
33	REAR PLINTH
34	ADJUSTABLE FEET
36	FRONT PLINTH
38	EXHAUST BODY
91	ADJUSTABLE FEET NUT (FIXED)
130	SIDE CLOSING PROFILE
148	CONCRETE WEIGHT
149	SCREW (CIRCULAR-HEAD, 4.8*32)
194	REAR BOTTOM LID
212	EXHAUST PROTECTION COVER
229	EXTRA BOTTOM SUPPORT
251	SIDE PANEL SUPPORT BRACKET
316	WHEEL ASSEMBLY
318	WHEEL (FREESTANDING COOKER)
409	ANTI-TIP BRACKET (GROUND TYPE)
410	ANTI-TIP BRACKET HOLDER
560	ANTI-TIP BRACKET (WALL TYPE)
<p>"The exploded views given in this document are generic.They incude all possible verisons of the product.For spesific part codes,please refer to the bom list of regarding model.</p>	

OVEN DOOR HANDLES (OPTIONAL)  
HANDLES WITHOUT TAP & BRACKET

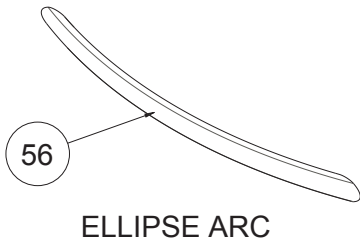

ELLIPSE ARC

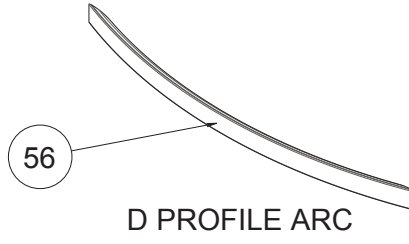

D PROFILE ARC

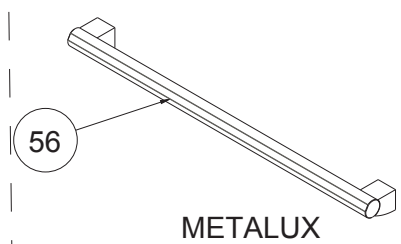

METALUX

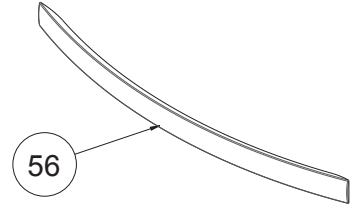

D PROFILE ARC, ELECTROLUX  
( ONLY FOR FS - OPTIONAL )

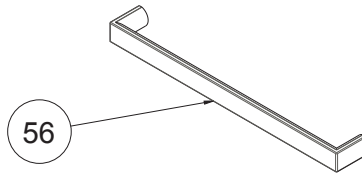

FNP ( ONLY FOR BUILT-IN -  
OPTIONAL )

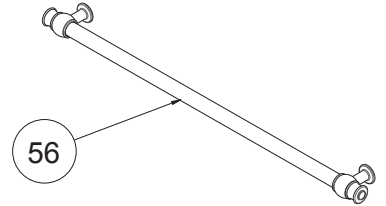

RUSTIC

HANDLES WITH BRACKET

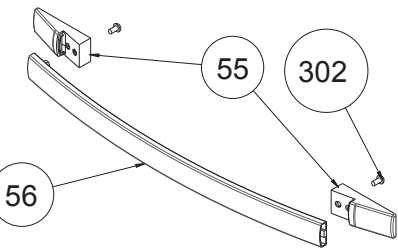

ARC QUADRANGLE

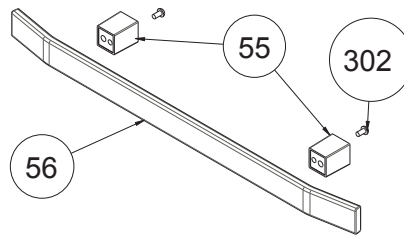

3D QUADRANGLE ( ONLY FOR  
FS/ NEW G/ BUILT-IN - OPTIONAL )

HANDLES WITH TUNNEL TAP

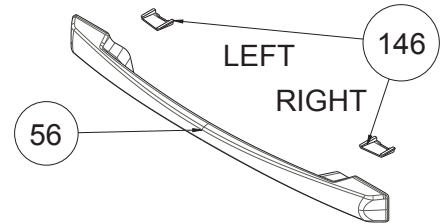

NO FAN TYPE ( ONLY FOR  
BUILT-IN - OPTIONAL )

HANDLES WITH TAP & BRACKET

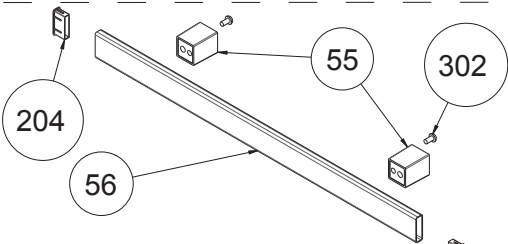

FLAT QUADRANGLE  
( ONLY FOR FS/ NEW G/ BUILT-IN - OPTIONAL )

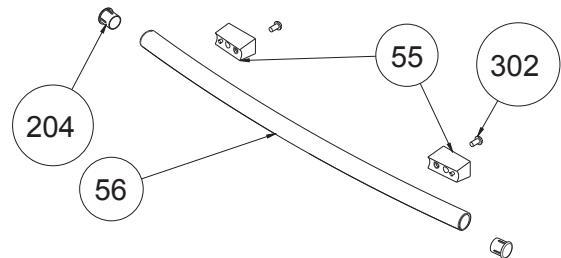

ARC TUBE

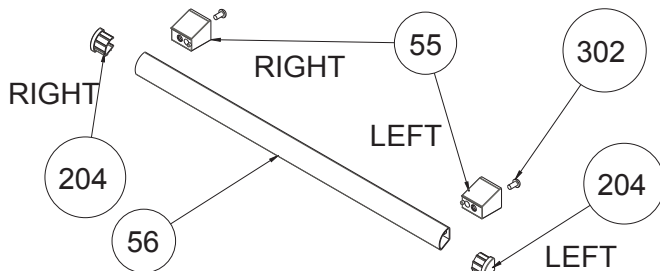

FLAT SLICE

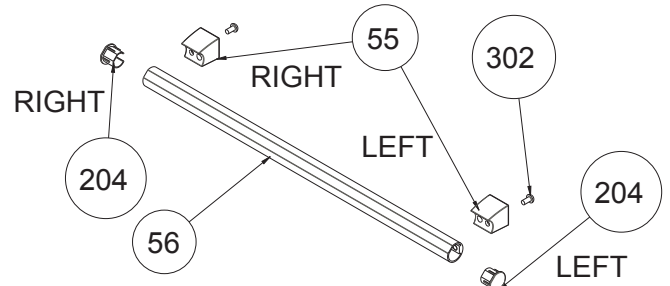

TRIO

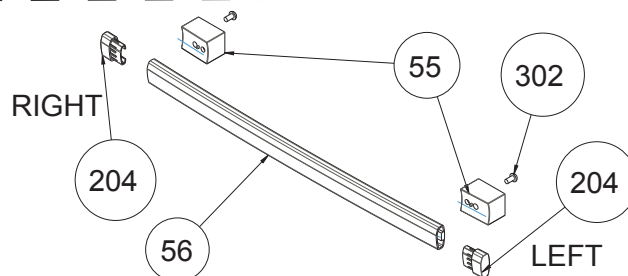

CURVED QUADRANGLE

KNOBS ( ONLY FOR NEW G - OPTIONAL )

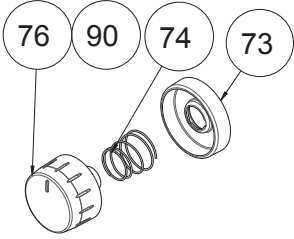

OMEGA

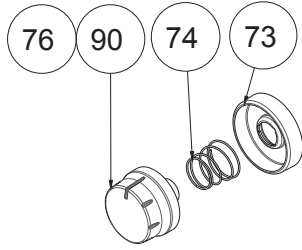

EPSILON

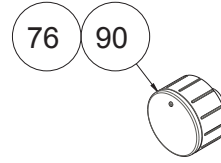

BIG MACRO  
( ONLY FOR NEW G ELECTRIC/  
NEW G VITROCERAMIC - OPTIONAL )

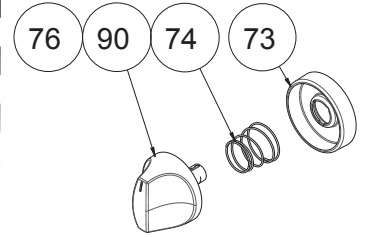

GAMA RING

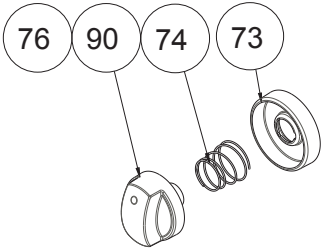

ECLIPSE RING

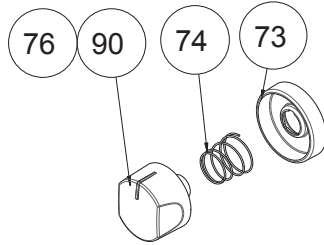

RIMO

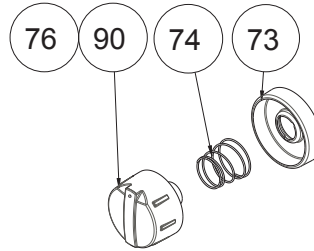

ANTERO

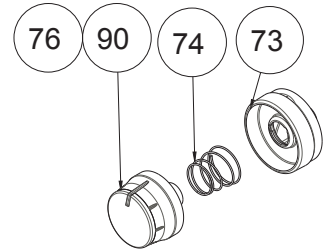

SPECTRUM

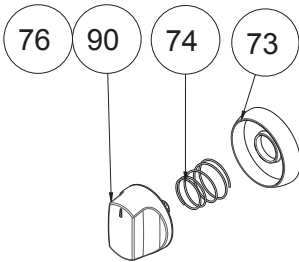

TRIO

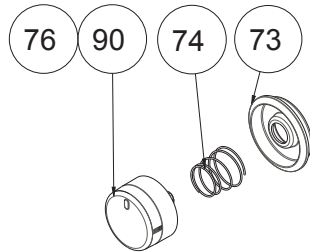

SIGMA

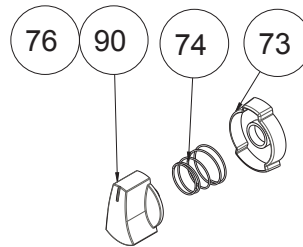

DELTA RING

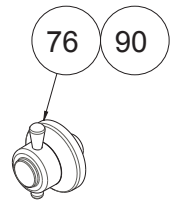

RUSTIC RISUS