



**improve your life**

**X3 ECO PLUS**  
**MULTI SPLIT AIR**  
**CONDITIONERS – R32**  
**INVERTER**

**USER and INSTALLATION MANUAL**

**OUTDOOR UNITS**

X3MI ECO 52SHB  
X3MI ECO 61SH  
X3MI ECO 71SH  
X3MI ECO 80SH  
X3MI ECO 105SH  
X3MI ECO 120SH

**INDOOR UNITS**

X3I ECO PLUS 27 HL WF  
X3I ECO PLUS 35 HL WF  
X3I ECO PLUS 52 HL WF  
X3I ECO PLUS 70HL WF

**Please read this manual carefully before installing and using the air conditioner, and retain for future reference.**

# Contents

<b>Information for use</b>	
The Refrigerant	51
Precautions for use	52
Description of components	54
<b>Guide to the remote control and display</b>	
Remote control buttons	56
Getting to know the display icons	57
Getting to know the remote control buttons	57
Getting to know the button combination functions	63
Operating guide	63
Replacing the remote control batteries	64
WiFi guide	65
Emergency operation	76
<b>Maintenance</b>	
Care and cleaning	76
<b>Troubleshooting</b>	
Possible faults and solutions	77
Analysing faults and solutions	79
<b>Installation instructions</b>	
Installation diagrams	80
Choosing a location for installation	82
Electrical connection requirements	82
<b>Installation</b>	
Indoor unit installation	83
Outdoor unit installation	87
Vacuum pump	89
Maintenance	90
Electrical connections	90
<b>Testing and operation</b>	
Post-installation checks	94
Safety operation of flammable refrigerant	94
Functional testing	96
<b>Appendices</b>	
Piping configuration	96
Procedure for extending the piping	96

## **INFORMATION FOR CORRECT DISPOSAL OF THE PRODUCT IN ACCORDANCE WITH THE EUROPEAN DIRECTIVE 2012/19/EU**



At the end of its working life this equipment must not be disposed of as an household waste. It must be taken to special local community waste collection centres or to a dealer providing this service. Disposing of electrical and electronic equipment separately avoids possible negative effects on the environment and human health deriving from an inappropriate disposal and enables its components to be recovered and recycled to obtain significant savings in energy and resources. In order to underline the duty to dispose of this equipment separately, the product is marked with a crossed-out dustbin.

# INFORMATION FOR USE

## The Refrigerant R32



Appliance filled with flammable gas R32.



Before using the appliance, read the owner's manual.



Before installing the appliance, read the installation manual.



Before repairing the appliance, read the service manual.

- To realize the function of the air conditioner unit, a special refrigerant circulates in the system. The refrigerant is the fluoride R32 = GWP (Global warming potential). This refrigerant is flammable and inodorous. It can lead to explosions under certain conditions, however the flammability of this refrigerant is very low and it can be ignited only by fire.
- Compared to other common refrigerants, R32 is a non-polluting refrigerant with no harm to the ozoneosphere and a lower effect upon the greenhouse effect. R32 has very good thermodynamic features which lead to a really high energy efficiency. The units therefore need less filling.

## Disclaimer of manufacturer's liability

The manufacturer assumes no responsibility for personal injury or loss of property caused by the following reasons

1. Damage to the product caused by improper use or abuse of the product.
2. Alter, change, store or use the product with equipment without following the manufacturer's instruction manual.
3. After verification, the product defect is directly caused by corrosive gas.
4. After verification, the defects are due to improper operations during the transport of the product.
5. Operate, repair, store the unit without following the instruction manual or related regulations.
6. After verification, the problem or dispute is caused by quality specifications or by the performance of parts or components produced by other manufacturers.
7. The damage is caused by natural disasters, bad use of the environment or force majeure

## Warning:

Do not try to accelerate the defrosting process or to clean the appliance in different ways other than those recommended by the manufacturer. Should repair be necessary, contact your nearest authorized Argoclima Service Centre. Any repairs carried out by unqualified personnel may be dangerous. The appliance has to be stored in a room that doesn't have any continuously operating ignition sources. (for example: open flames, an operating gas appliance or an operating electric heater.) Do not pierce or burn.

Appliance has to be installed, operated and stored in a room with a floor area larger than X m<sup>2</sup>. (Please refer to table "a" in section of " Safety Operation of Inflammable Refrigerant" for Space X.)

For repairs, strictly follow manufacturer's instructions only for appliances filled with R32 flammable gas. Be aware that refrigerants do not have any odour.

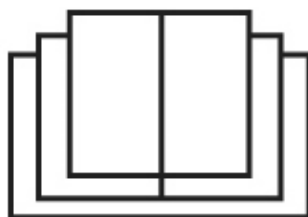

## INFORMATION FOR USE





### Precautions for use

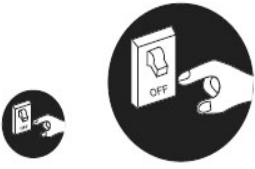

#### WARNING

- This product is not a toy. Children of less than 3 years should be kept away unless continuously supervised.
- This device is not intended for persons (including children aged from 8 years and above) with reduced physical, sensory or mental capabilities, or without the necessary experience and knowledge, unless they have received the necessary supervision or instruction concerning use of the appliance by a person responsible for their safety.
- Children aged from 3 and less than 8 years shall only switch on/off the appliance provided that it has been placed or installed in its intended normal operating position and they have been given instruction concerning use of the appliance in a safe way and understand the hazards involved. Children aged from 3 years and less than 8 years shall not plug in, regulate and clean the appliance or perform user maintenance.
- To prevent the risk of fire, do not connect the air conditioner to a multifunction socket.
- Always disconnect the power before servicing or cleaning the unit.
- To prevent the risk of electric shock or malfunction, do not spray water on the indoor unit.

- Do not spill water on the remote control.
- To prevent the risk of electrical shock or damage, do not attempt to repair the air conditioner yourself. After performing the checks in the troubleshooting section, contact an authorised service centre.
- Do not obstruct the inlet or outlet. Otherwise, a fault may occur.
- Contact a qualified technician if it is necessary to move the air conditioner to another location.
- Do not climb on or place heavy objects on the top panel of the outdoor unit. Otherwise, there is a risk of damage or personal injury.
- Do not put fingers or other objects in the air inlet/outlet grilles. Otherwise, there is a risk of damage or personal injury.
- The air conditioner must be properly earthed. Improper earthing can cause electrical shock.
- Always install a circuit breaker. Otherwise, a fault may occur.
- The unit must be installed and serviced by a qualified technician. Otherwise, there is a risk of damage or personal injury.
- Frequency band(s) in which the radio equipment operates 2400MHz-2483.5MHz.
- Maximum radio-frequency power transmitted in the frequency band(s) in which the radio equipment operates: 20dBm.

<b>WARNING</b>		
<p>★ In case of smoke or burning smell, turn off the power supply and contact the service center.</p>  <p>If the problem persists, the unit could be damaged and cause electrical shock or fire.</p>	<p>★ It is necessary that power supply adopts the special circuit with protection through an air switch and ensure it has sufficient capacity. The unit switches on or off automatically according to user needs: do not turn on or turn off the device frequently otherwise it could suffer harmful effects.</p>	<p>★ Do not cut or damage the power cords and control cables. If the power cable and the cable of the control signal are damaged, they must be replaced by a professional technician.</p> 
<p>★ The power supply must be equipped with a special circuit to prevent fire.</p>  <p>Otherwise, it may result in fire or electric shock.</p>	<p>★ Disconnect the power supply if the air conditioner is not used for a long time</p>  <p>Otherwise, the accumulation of dust can cause overheating.</p>	<p>★ Do not damage the power cord or use an unauthorized cable.</p>  <p>Otherwise, it may cause overheating or fire.</p>

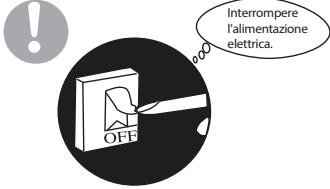
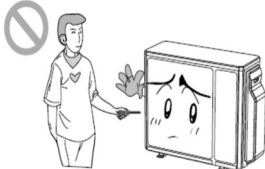
<p>★ When cleaning the unit, stop operation and turn off the power.</p>  <p>Otherwise, may occur electric shock or damage.</p>	<p>★ The voltage rating of this product is 220 - 240V, 50Hz. The compressor vibrates strongly if the voltage is too low, causing damage to the cooling system. The electrical components are easily damaged if the voltage is too high.</p>	<p>★ Do not attempt to repair the air conditioner yourself.</p> <p>An improper repair can cause fire or electric shock. For this reason, it is advisable to contact a service center for repairs.</p>
<p>★ Check if the installed media is sufficiently stable.</p> <p>If damaged, it can cause the equipment to fall and cause injury.</p>	<p>★ Do not climb on the outdoor unit or place anything on it.</p> <p>The falling of the outdoor unit can be dangerous</p>	<p>★ Earthing: The unit must be properly grounded. The cable grounding must be connected with the appropriate device in the building.</p> 

## Operating limits

Operating range:

Cooling mode: from -15°C to +43°C (outdoor temperature)

Heating mode: from -15°C to +24°C (outdoor temperature)

## Description of components

### Indoor unit

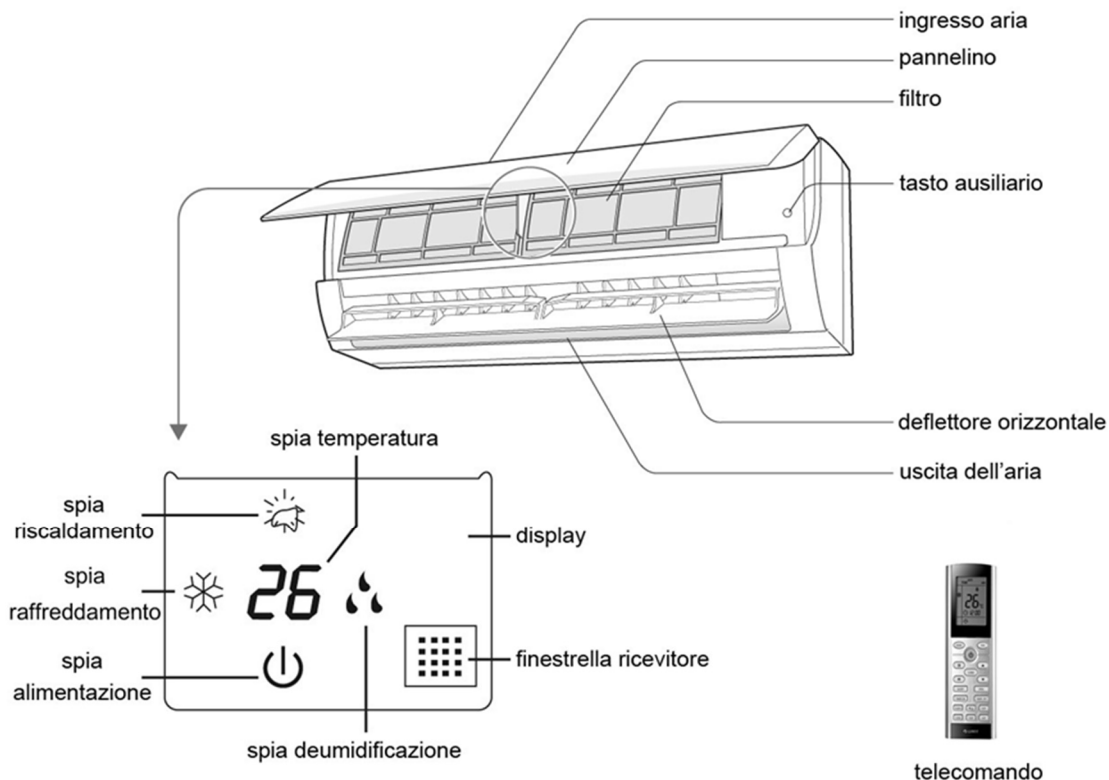

ingresso aria	air inlet
pannellino	panel
filtro	filter
Tasto ausiliario	auxiliary button
Deflettore orizzontale	horizontal flap
uscitadell'aria	air outlet
Spia alimentazione	power indicator
Finestrella ricevitore	receiver window
Spia temperatura	temperature indicator
telecomando	remote control
Spia riscaldamento	Heating indicator
Spia raffreddamento	Cooling indicator

The display may vary from the graphic above. Please refer to the purchased product for the actual display content and positions)

## Outdoor unit

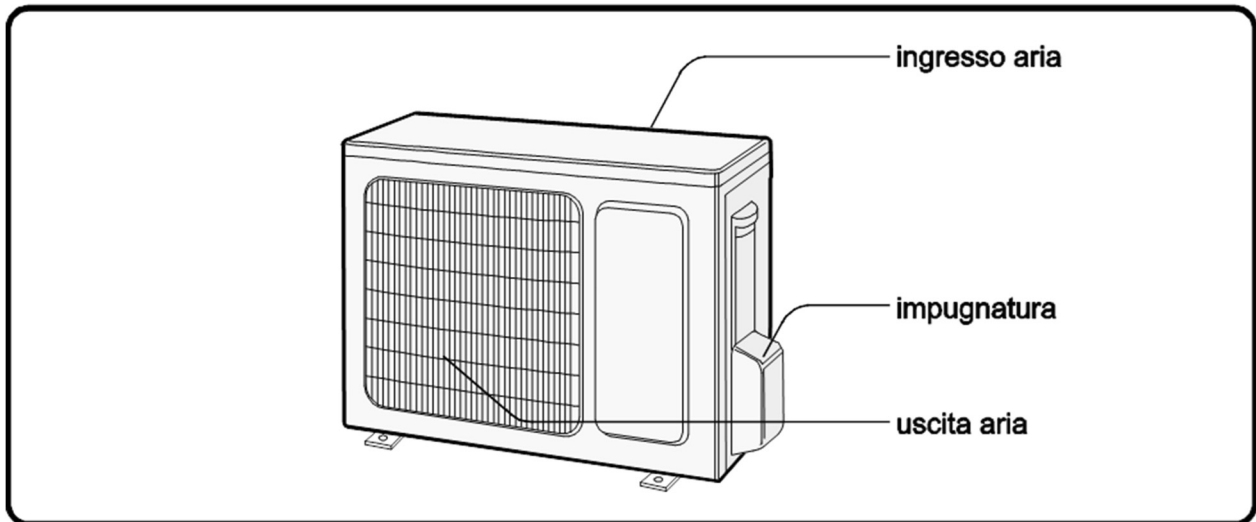

Unità esterna	Outdoor unit
ingresso aria	air inlet
impugnatura	handle
uscita aria	air outlet

## GUIDE TO THE REMOTE CONTROL AND DISPLAY

### Remote control buttons



- 1 ON/OFF button
- 2 MODE button
- 3 FAN button
- 4 TURBO button
- 5 ▲/ ▼ button
- 6 button
- 7 button
- 8 SLEEP button
- 9 I FEEL button
- 10 TIMER ON / TIMER OFF button
- 11 CLOCK button
- 12 QUIET button
- 13 WiFi button
- 14 LIGHT button
- 15 button
- 16 TEMP button



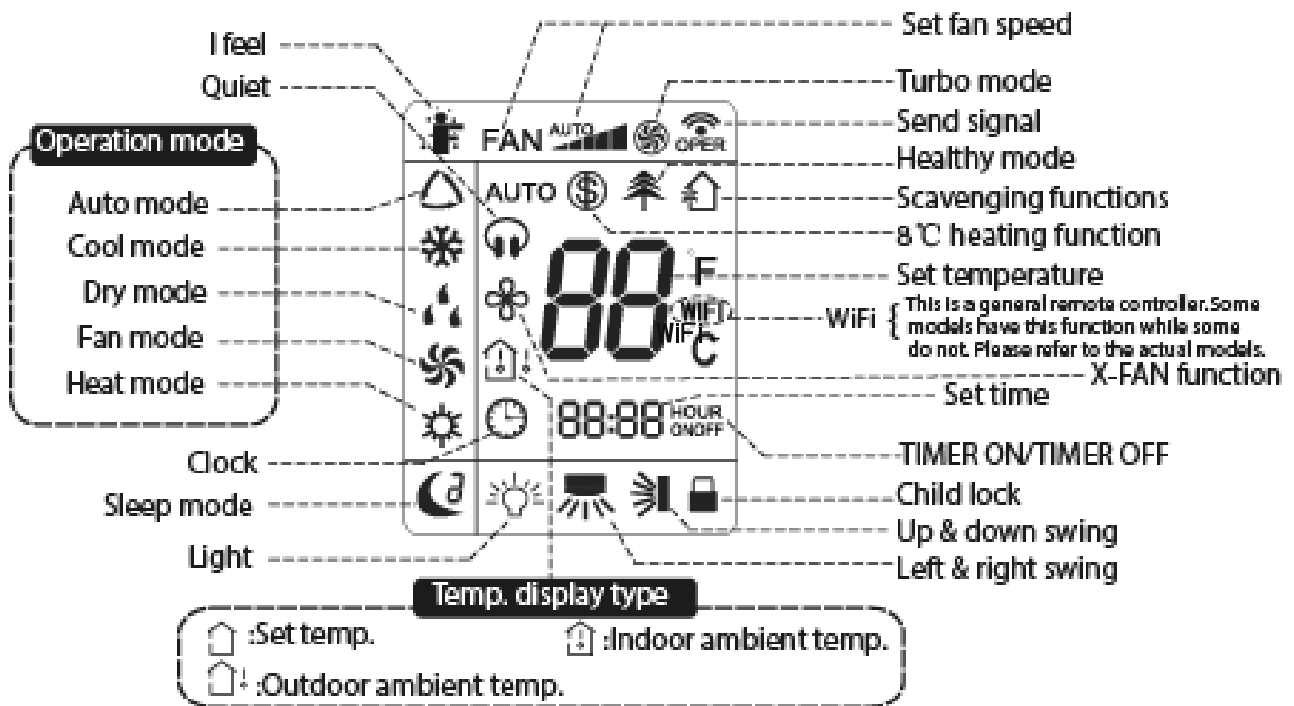

## Getting to know the display icons



## Getting to know the remote control buttons

### N.B.:

- When you connect the power, the air conditioner will emit a beep. The power indicator  will illuminate (red). You will now be able to control the air conditioner with the remote control.
- With unit on, when you press the ON/OFF button on the remote control, the  icon on the remote control display will flash once and the air conditioner will emit a beep. This means that the signal has been sent to the unit. When the unit is on, the icons for the set functions will appear on the display.
- This remote control can control the temperature in Auto mode.
- If the air conditioner is equipped with WIFI or wired control, you must first control the unit in Auto mode with the standard remote control and then you can connect it to the app and set the temperature in Auto mode via smart-phone or wired control.
- If the remote control is combined with a unit that can't control the temperature in Auto mode, the temperature set in this mode may not be valid or the temperature shown on the unit display may not match that shown on the remote control's display in Auto mode.

### 1. ON/OFF button

Press the ON/OFF button to turn the air conditioner on or off. When you turn on the air conditioner, the power indicator  on the indoor unit's display will illuminate (green). The colour varies for different models. The indoor unit will emit a beep.

### 2. MODE button

Press this button to select the desired operating mode.



- When you select automatic mode, the air conditioner will operate automatically according to the factory settings. The set temperature cannot be adjusted and will not be displayed. Pressing the

"FAN" button will allow you to adjust the fan speed. Pressing the "SWING" button will allow you to adjust the angle of airflow.

**N.B. When several indoor units are connected to the same outdoor unit, do not select the AUTO mode, unless only one indoor unit is used and the others are switched off. All the units must in fact operate in the same mode: if the mode selected or automatically defined is different for the units connected to the same outdoor unit, the system goes into error and the error E7 appears on the display of the indoor unit.**

- When you select cool mode, the air conditioner will run in cool mode. The ☼ indicator will illuminate on the display. Press "▲" or "▼" to adjust the set temperature. Press the "FAN" button to adjust the fan speed. Pressing the "SWING" button will allow you to adjust the angle of airflow.
- When you select dry mode, the air conditioner will run at low speed in dry mode. The 💧 indicator will illuminate on the display. The fan speed cannot be adjusted in this mode. Pressing the "SWING" button will allow you to adjust the angle of airflow.
- When you select fan mode, the air conditioner will operate only the fan, blowing air without cooling or heating. All the indicators will switch off. Press the "FAN" button to adjust the fan speed. Pressing the "SWING" button will allow you to adjust the angle of airflow.
- When you select heat mode, the air conditioner will run in heat mode. The ☀ indicator will illuminate on the display. Press "▲" or "▼" to adjust the set temperature. Press the "FAN" button to adjust the fan speed. Pressing the "SWING" button will allow you to adjust the angle of airflow.

**N.B.:**

To prevent blasts of cold air from being blown into the room, there will be a delay of 1 – 5 minutes after selecting heat mode before operation begins. (The actual delay will depend on the indoor ambient temperature).

The temperature can be set between 16 – 30°C and four fan speeds are available: automatic, low, medium and high.

**3. FAN button**

Pressing this button will allow you to cycle through and set the fan speed:

automatic (AUTO), Low (▀), Low-medium (▀▀) Medium (▀▀▀), Medium-high (▀▀▀▀), High (▀▀▀▀▀).



**N.B.:**

The fan speed in dehumidification mode is low.

Pressing the ventilation speed button for 2 seconds in Cooling or Dehumidification mode activates the X-FAN function and the icon appears on the remote control: the unit will continue to ventilate for a few minutes, even after switching off the unit, to dry the battery of the indoor unit, thus preventing the formation of mold. This function is not available in Auto, Ventilation or Heating mode. If the X-FAN function has been selected: after turning off the unit with the ON / OFF button, the indoor unit fan will continue to run for a few minutes at low speed. During this time, press the FAN key for 2 seconds to stop the fan.

If the X-FAN function is not selected, when the air conditioner is switched off by pressing the ON / OFF button, the fan goes off together with the unit.

**4. TURBO button**

In cool/heat mode, press this button to switch to rapid cool/heat mode. The 🌀 icon will appear on the remote control display. Press this button again to exit the TURBO function. The 🌀 icon will disappear from the display. If start this function, the unit will run at super-high fan speed to cool or

heat quickly so that the ambient temperature approaches the pre-set temperature as soon as possible.

### 5. ▲/ ▼ button

Press "▲" or "▼" once to increase or decrease the set temperature by 1°C. Press and hold "▲" or "▼" for 2 seconds to rapidly adjust the set temperature on the remote control. When set-up is complete, release the button and the indoor unit's temperature indicator will change accordingly. (The temperature cannot be adjusted in automatic mode).

When setting the TIMER ON, TIMER OFF or CLOCK, press "▲" or "▼" to adjust the time. (Please refer to the relevant sections for the CLOCK, TIMER ON and TIMER OFF buttons).

### 6. SWING (Horizontal) button

Press this button to set the angle of inclination of the flap to the left and right. The flow outlet angle can be set circularly, according to the sequence shown below:

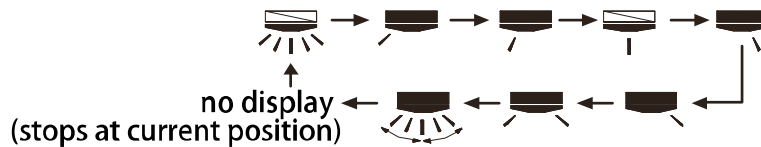





Note:

- Keeping this button pressed for more than 2 seconds the flap will swing to the left and right; leaving the key the flap will stop and the current position of the flap will be maintained.
- In the SWING mode, when switching from off to this mode, if you press the button again after 2 sec. has elapsed, the unit will go directly off; if instead the key is pressed a second time before 2 sec. has passed, the change in the position of the flap will follow the sequence illustrated above.

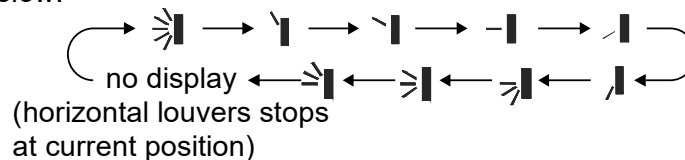
### 7. SWING (vertical) button

Press this button to set the swing angle (up/down). You can cycle through and set the fan's angle of airflow as shown below:



- When you select , the air conditioner will operate the fan automatically. The horizontal flap will automatically tilt up and down to the maximum angle.
- When you select , the air conditioner will operate the fan in a fixed position. The horizontal flap will stop in a fixed position.
- When you select , the air conditioner will operate the fan at a fixed angle. The horizontal flap will deliver air at a fixed angle.
- Hold and press the  button for 2 seconds to set the desired tilt angle. Release the button once you have reached the desired angle.

**N.B.:**

-  may not be available. When the air conditioner receives this signal, the fan will start operating in automatic mode.

## 8. SLEEP button

By pressing this button you can select Sleep 1, Sleep 2, Sleep 3 and cancel the Sleep function.

- **SLEEP 1** works in cooling and dehumidification mode: after one hour of unit operation, the temperature will increase by 1°C, after 2 hours it will increase by 2°C; in heating mode, after one hour of unit operation, the temperature will decrease by 1°C and after two hours will decrease by 2°C.

- **SLEEP 2** the air conditioning operates on the basis of pre-set temperature curves.

In cooling mode:

1. When the initial temperature is set to 16°C-23°C, after activating the Sleep function, the temperature will increase by 1°C every hour, after three hours the temperature will stabilize, after 7 hours the temperature will decrease by 1°C and the unit will start working constantly.

2. When the initial temperature is set to 24°C-27°C, after activating the Sleep function, the temperature will increase by 1°C every hour, after two hours the temperature will stabilize, after 7 hours the temperature will decrease by 1°C and the unit will start working constantly.

In heating mode:

1. When the initial temperature is set to 17°C-20°C, after activating the Sleep function, the temperature will decrease by 1°C every hour, after one hour the temperature will decrease and the unit will maintain this constant temperature.

2. When the initial temperature is set to 21°C-27°C, after activating the Sleep function, the temperature will decrease by 1°C every hour, after two hours the temperature will decrease and the unit will maintain this constant temperature.

3. When the initial temperature is set to 28°C-30°C, after activating the Sleep function, the temperature will decrease by 1°C every hour, after three hours the temperature will decrease and the unit will maintain this constant temperature.

- **SLEEP 3**: it is possible to customize the sleep curve: in this mode, keep the "TURBO" key pressed for a long time to access the setting of the CUSTOM SLEEP function.

1. The remote control timer display shows "1 hr" and the set temperature indication "88" displays the corresponding temperature of the last set sleep curve and flashes (the first data item is linked to the initial values of the curve set in factory).

2. Press "▲" and "▼" to adjust the corresponding temperature. After adjustment, press the "TURBO" key to confirm.

3. At this point, the time of the timer on the remote control increases automatically in steps of 1 (ie "2 hr" or "3 hr" ... or "8 hr"). The set temperature indication "88" displays the corresponding temperature of the last set sleep curve and flashes.

4. Repeat steps (2) and (3) until the temperature setting is complete for 8 hours; at this point the sleep curve is set correctly. When this operation is completed, the remote control resumes displaying the time of the initial timer and the temperature displayed is the one initially set.

## 9. I FEEL function

Press this button to start the I FEEL function. The  icon will appear on the remote control display. When you select this function, the remote control will send the detected ambient temperature to the indoor unit, which will then adjust its operation automatically based on the difference between the detected temperature and the set temperature.

Press the button again to exit the I FEEL function. The  icon will disappear from the display.

**The remote control should be positioned near the user when this function is selected. The remote control should not be placed anywhere high or low temperatures may occur to avoid inaccurate ambient temperature detection.**

Place the remote control near the user when this function is set. Do not place the remote control near high or low temperature objects to avoid an inaccurate ambient temperature. Position the remote control where the indoor unit can receive the remote control signal.

## 10. TIMER ON / TIMER OFF button

### SETTING TIMER ON



This function allows you to program the air conditioner to turn on. When you press this button, the  icon will disappear from the display and the word "ON" will flash on the remote control display. Press "▲" or "▼" to adjust the TIMER ON setting.

Press and hold "▲" or "▼" for 2 seconds to rapidly change the time until you reach the desired value. Press TIMER ON to confirm. The word "ON" will stop flashing. The  icon will re-appear on the display.

### CANCELLING TIMER ON

If the TIMER ON function is enabled, press the TIMER ON button to cancel the setting.

### SETTING TIMER OFF

This function allows you to program the air conditioner to turn off. When you press this button, the  icon will disappear from the display and the word "OFF" will flash on the remote control display. Press "▲" or "▼" to adjust the TIMER OFF setting. Press and hold "▲" or "▼" for 2 seconds to rapidly change the time until you reach the desired value. Press "TIMER OFF". The word "OFF" will stop flashing. The  icon will re-appear on the display.



### CANCELLING TIMER OFF

If the TIMER OFF function is enabled, press the TIMER OFF button to cancel the setting.

### N.B.:

- You can set the TIMER ON and TIMER OFF function in OFF and ON mode.
- Before you set the TIMER ON or TIMER OFF function, set the clock.
- When the TIMER ON or TIMER OFF function is enabled, the air conditioner will turn on or off according to the set time. Turning the air conditioner ON/OFF will not affect the setting.

## 11. CLOCK button

Press this button to set the clock. The  icon will flash on the remote control display. Press "▲" or "▼" within 5 seconds to set the clock. Each time you press "▲" or "▼", the clock will increase or decrease by 1 minute. Press and hold "▲" or "▼" for 2 seconds to rapidly change the time. Release the button when you reach the desired time. Press "CLOCK" to confirm the time. The  icon will stop flashing.

### N.B.:

- The time displays in the 24-hour clock format.
- If no adjustment is made for 5 seconds the remote control will exit the setting mode. This also applies to the TIMER ON/OFF function.

## 14. QUIET button

1. When the Quiet function is selected, the symbol will appear on the display .
2. In cooling mode the internal fan works with 4 steps of speed; 10 minutes later or when the indoor temperature is  $\leq 28^{\circ}\text{C}$ , the internal fan will operate at step 2 or in quiet mode, ie in accordance with a comparison between the internal temperature of the environment and the set temperature.
3. In heating mode the internal fan operates with step 3 of speed or in quiet mode, ie in accordance with a comparison between the internal temperature of the room and the set temperature.
4. In the dehumidification and ventilation mode the internal fan operates in quiet mode.

5. In auto mode the internal fan operates in auto quiet mode according to the current modes: cooling, heating and ventilation.



## 12. LIGHT button

Press this button to start the Wi-Fi function. When the Wi-Fi function is active, the "Wi-Fi" icon will appear on the remote control display. When the remote control is off, press and hold the "Mode" button and the "Wi-Fi" button simultaneously for 1 sec to return to the factory settings.

## 13. Wi-Fi button

Press this button to start the Wi-Fi function. When the Wi-Fi function is active, the "Wi-Fi" icon will appear on the remote control display. When the remote control is off, press and hold the "Mode" button and the "Wi-Fi" button simultaneously for 1 sec to return to the factory settings.

## 14. LIGHT button

Press this button to turn off the indoor unit's display light. The  icon will disappear from the remote control display. Press this button again to turn on the display light. The  icon will appear on the display.

## 15. HEALTH/SCAVENGING button

The HEALTHY function means that cold plasma kills bacteria, removes odors and releases negative oxygen ions.

The SCAVENGING or purification function means active external / internal ventilation to exhaust the air drawn in by the environment and to introduce fresh air.

Press this button once to start the air purification function: the symbol appears on the display.

Press the button a second time to start the purification and sanitizing function at the same time,

symbols  and  appear.

Press the button for the third time to turn off both functions.



Press the button the fourth time to start the sanitizing function, appears .

Press this button again to repeat the operations listed above.

## 16. TEMP button

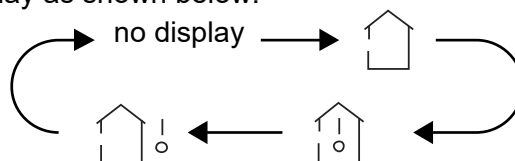
Pressing this button will allow you to display the set temperature, the indoor ambient temperature, or the outdoor ambient temperature on the indoor unit's display. You can cycle through the settings on the remote control display as shown below:



- When you select  or "no display" with the remote control, the set temperature will appear on the indoor unit's display.
- When you select  with the remote control, the indoor ambient temperature will appear on the indoor unit's display.
- When you select  with the remote control, the outdoor ambient temperature will appear on the indoor unit's display.

### N.B.:

- It is not possible to display the outdoor ambient temperature on all models. The indoor unit will receive the  signal but will display the set temperature.
- The set temperature will appear on the unit's display on start-up, if enabled to do so.
- When you select to display the indoor or outdoor ambient temperature, the indoor unit will display the corresponding temperature for three to five seconds, after which it will automatically revert to displaying the set temperature.

# Getting to know the button combination functions

## Energy saving function

In cool mode, press the TEMP and CLOCK buttons simultaneously to start or stop the energy saving function. When you start the energy saving function, "SE" will appear on the remote control display and the air conditioner will automatically adjust the set temperature according to the factory settings to achieve the best energy-saving effect. Press TEMP and CLOCK again simultaneously to exit the energy saving function.

### N.B.:

- When the energy saving function is enabled, the fan will operate at the default automatic speed and cannot be adjusted.
- When the energy saving function is enabled, the set temperature cannot be adjusted. The remote control will not send a signal to the unit when the TURBO button is pressed.
- The SLEEP and energy saving functions cannot operate simultaneously. If the energy saving function was set in cool mode, press the SLEEP button to cancel it. If the SLEEP function was set in cool mode, start the energy saving function to cancel it.

## 8°C heating function

In cool mode, press the TEMP and CLOCK buttons simultaneously to start or stop the 8°C heating function. When this function is enabled,  and 8°C will appear on the remote control display and the air conditioner will continue to operate at 8°C. Press TEMP and CLOCK again simultaneously to exit the 8°C heating function.



### N.B.:

- When the 8°C heating function is enabled, the fan will operate at the default automatic speed and cannot be adjusted. The remote control will not send a signal to the unit when the TURBO button is pressed.

The SLEEP and 8°C heating functions cannot operate simultaneously. If the 8°C heating function was set in cool mode, pressing the SLEEP button will cancel it. If the SLEEP function was set in cool mode, starting the 8°C heating function will cancel it.

- When the temperature display is in °F, the remote control will show that the unit is operating at 46°F.

## Remote control button lock function

Press "▲" and "▼" simultaneously to enable or disable the remote control button lock function. When this function is enabled,  will appear on the remote control display. If you attempt to operate the remote control, the  icon will flash three times and no signal will be sent to the unit.

## Switching temperature display

In OFF mode, press the "▼" and "MODE" buttons simultaneously to switch from a temperature display in °C to °F.

# Operating guide

1. When you connect the power, press the "ON/OFF" button on the remote control to turn the air conditioner on.
2. Press the MODE button to select the desired operating mode: AUTO, COOL, DRY, FAN or HEAT.
3. Press "▲" or "▼" to adjust the desired temperature. (The temperature cannot be adjusted in automatic mode.)
4. Press the "FAN" button to set the desired fan speed: automatic, low, medium or high.
5. Press the "SWING" button to adjust the fan's angle of airflow.

# Replacing the remote control batteries

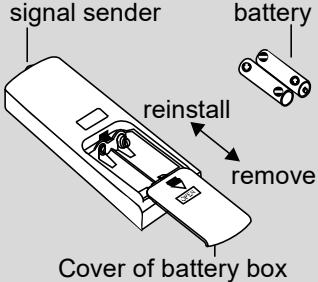
<ol style="list-style-type: none"><li>1. Remove the battery compartment cover, marked with  OPEN (see image to right), by sliding it in the direction of the arrow.</li><li>2. Use only two AAA – LR03 1.5V batteries. Make sure the + and – ends are facing the correct direction.</li><li>3. Slide the battery compartment cover back into place.</li></ol>	 <p>The diagram illustrates the process of opening and closing the battery compartment. It shows a remote control with the cover partially open. An arrow labeled 'remove' points to the cover being lifted away, and an arrow labeled 'reinstall' points to the cover being pushed back into place. A battery is shown being inserted into the compartment. Labels include 'signal sender' pointing to the top of the remote, 'battery' pointing to the AAA battery, and 'Cover of battery box' pointing to the bottom of the compartment.</p>
--	--

## N.B.:

- When the unit is operating, point the remote control's signal transmitter at the indoor unit's receiver.
- The distance between the transmitter and the receiver must not exceed 8 metres and should remain free of obstacles.
- If the room contains a fluorescent light or cordless telephone, signal interference is likely to occur.
- When the remote control is not used for a month or more, remove the batteries.
- Use batteries of the same type when replacing the batteries, as necessary.
- If the icons on the remote control display are blurred or not visible, replace the batteries.
- Do not attempt to recharge the batteries. Replace both batteries at the same time.
- Do not throw batteries into fire; they may explode.

## INFORMATION FOR THE CORRECT DISPOSAL OF BATTERIES IN ACCORDANCE WITH EUROPEAN DIRECTIVE 2006/66/EC and amendments Directive 2013/56/EC



Replace batteries when they are depleted. At the end of their life, batteries must be disposed of separately from unsorted waste. They must be taken to designated recycling centres or returned to a retailer providing this service. Separate disposal of batteries helps to reduce the potential harmful effects on the environment and human health caused by their improper disposal and also enables the recovery and recycling of component materials, saving significant energy and resources. The requirement for separate disposal is indicated by the crossed-out wheeled bin label affixed to the appliance. Illegal disposal of the product by the user is subject to administrative penalties as per current regulations.



# WIFI GUIDE

## How to set and operate the air conditioner with Wifi

1. Make sure that the device (smartphone or Tablet) used is equipped with a standard version of Android (version 4.4 or higher) and iOS (iOS7.0 or higher) as the operating system. For more details refer to the App.
2. Units can be connected and controlled only via Wi-Fi network or via Hotspot function.
3. Routers with WEP encryption are not supported.
4. The application interface is universal for all products and many features may not match for all units. It may vary depending on the operating system used or the update in use. Refer to the current version.
5. If the access protection on your Router is active in the "MAC Filter" / "MAC address filter" item, enable the access to the network of the MAC address of the device.

## Installation and use instruction

1. Frame the QR Code using a *QR Code Reader*



or search for the "**EWPE SMART**" application in the app store



download and install the application.

Install the App by referring to its guide. Once the installation is complete, the icon



### **NB:**

**Before starting any procedure, disconnect the power supply from the product, allow a few minutes to pass and reconnect it.**

## 2. Registration and access.

After installing the application, open "EWPE SMART" and click Sign up to register.

### PLEASE NOTE:

- USERNAME: must be UNIQUE, composed of name + number, without spaces (eg **Rossi57**)
- Personal email: if already registered, retrieve Username / Password. It is not possible to create another account with the same mail.
- PASSWORD: must have at least one capital letter, symbols or special characters (- ; , etc.) and numbers.
- Repeat PASSWORD written above
- EUROPE country

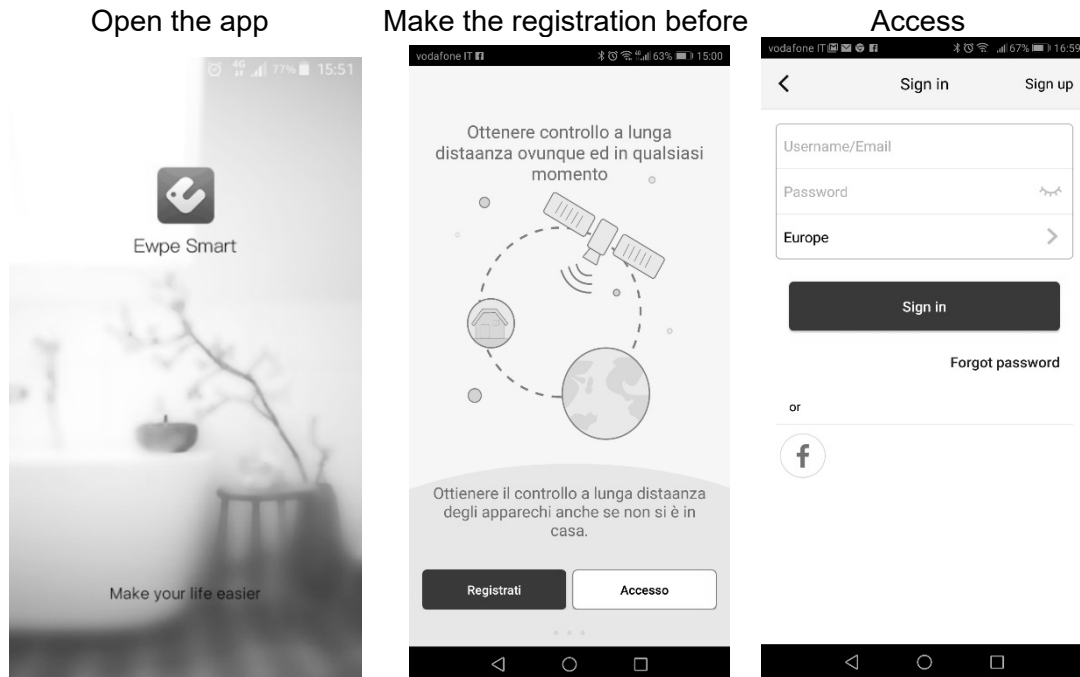

## 3. Adding units

Clicking on the icon of the little man opens a menu that includes, among other things, the "Help" function.

Follow the instructions that appear on your device to add the unit. or add a new unit, press + in the upper right corner of the homepage.

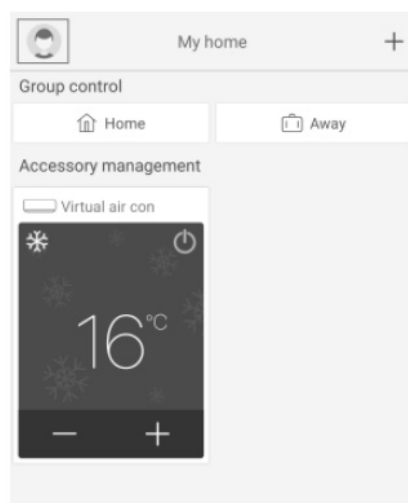

A menu appears with all the categories of devices that can be connected.

Select the relevant type:

In case of **residential air conditioner**: the first box on left

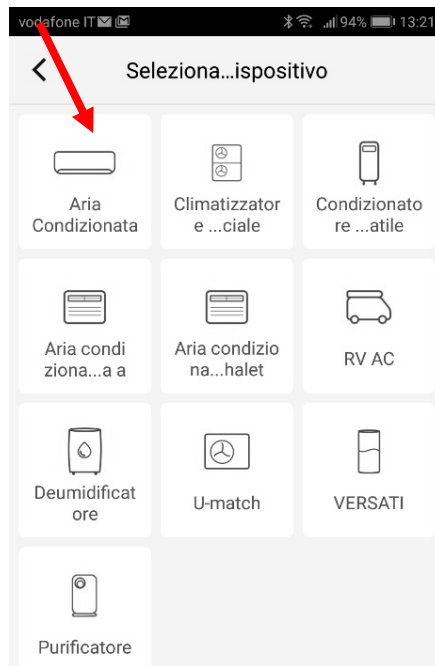

After choosing the category of interest, proceed with the reset of the unit.

Different unit reset systems can be chosen depending on the type of unit / system and remote control (with or without wifi key).

**Follow step by step** the operative instructions depending on the selected reset system.



After performing the reset following the instructions, click on Next to automatically add the unit (it's necessary to enter Wi-Fi password).



**WIRE CONTROL OR PORTABLE AIR CONDITIONER (CONTROL PANEL RESET)**

Press the button on the touch panel.

With the unit off, press and hold the "Wifi" button for 10 seconds. When the unit beeps, it means the reset has been successful.

**NB:**

The configuration must be done within 2 minutes. If it does not happen within 2 minutes, repeat the reset operation.

**REMOTE CONTROL WITH WIFI BUTTON**

Direct the remote control towards the unit.

With the remote control off, press the "Mode" + "Wifi" buttons simultaneously for 1 second. When the unit beeps, it means that the reset has been successful.

**NB:**

The configuration must be done within 2 minutes. If it does not happen within 2 minutes, repeat the reset operation..

**REMOTE CONTROL WITHOUT WIFI BUTTON (MODE and TURBO)**

Direct the remote control towards the unit.

Press the "Mode" + "Turbo" buttons simultaneously for 10 seconds. After the unit has twice produced an acoustic signal, this will mean that the reset has been successful.

**NB:**

The configuration must be done within 2 minutes. If it does not happen within 2 minutes, repeat the reset operation

Alternatively, after setting and resetting the air conditioner, click on *Add appliance manually* in the upper right corner to select the Wi-Fi network to associate.

Select the desired network and continue the configuration.

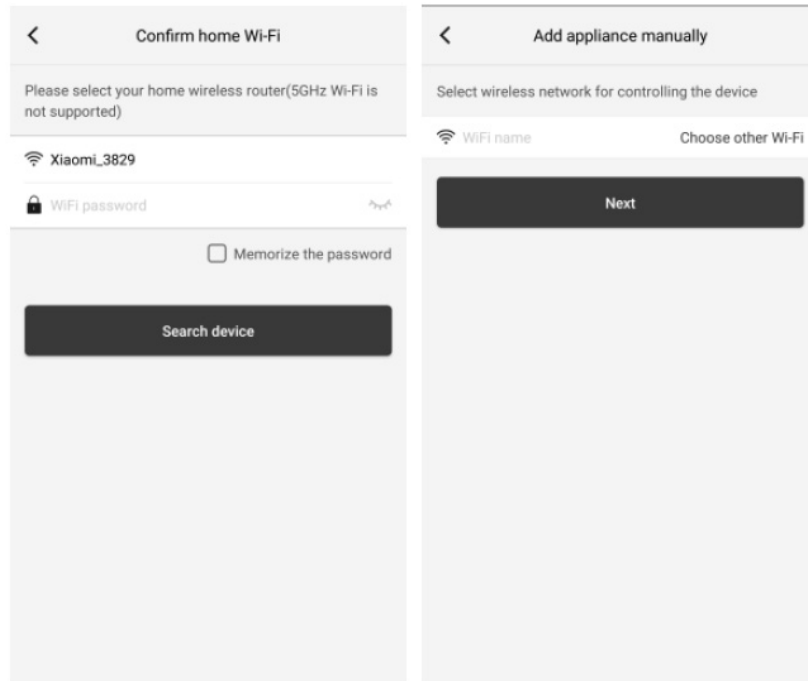

After performing the electrical reset of the unit and entering the information, perform a search for the unit (Search appliance) and continue the configuration.

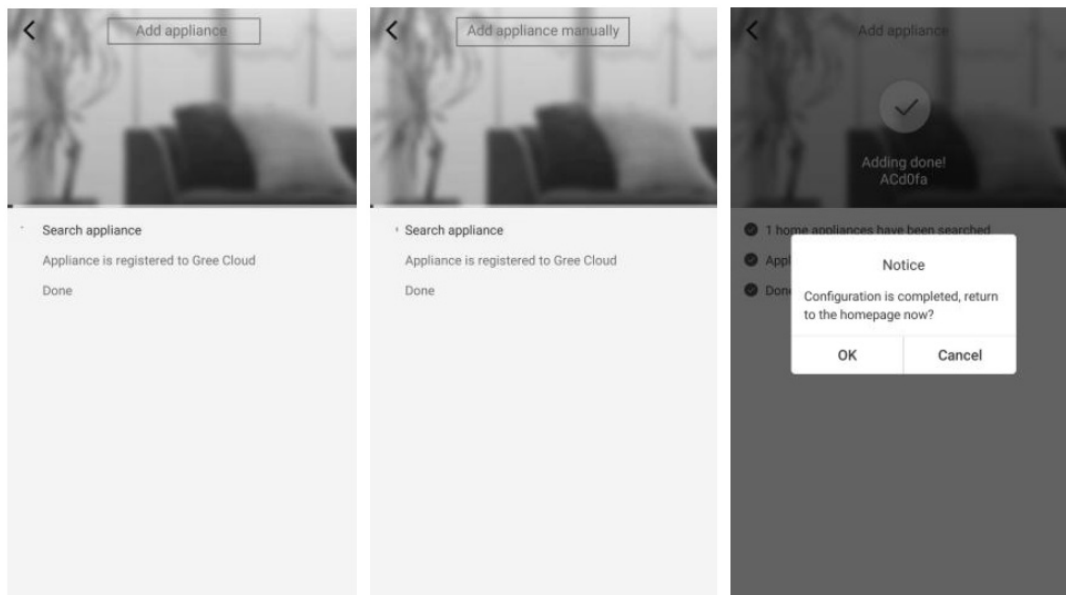

# Configuration of the main functions

In the Homepage click on the device you wish to control and access the operating interface of it.

## 1. Select, operating mode, temperature and fan speed.

- **Mode**

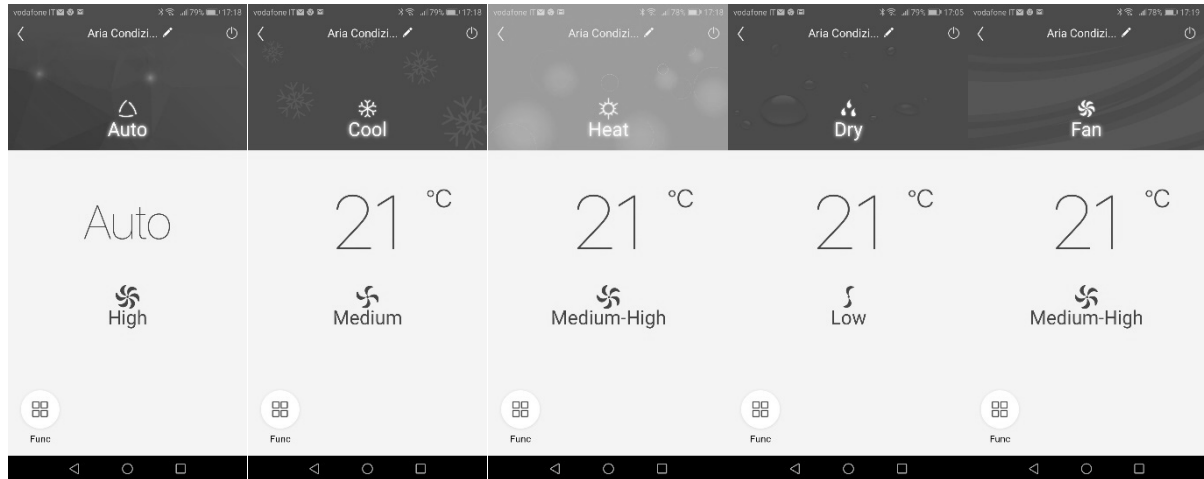

## 2. Temperature for each mode: just slide your finger on the indicated temperature

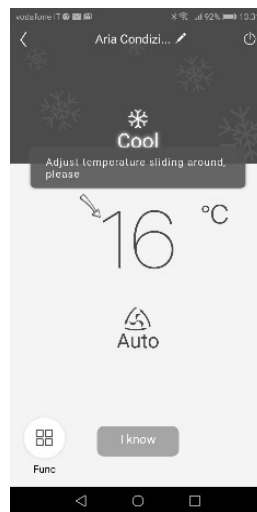

3. Ventilation speed for each mode: just slide your finger on the fan symbol (the adjustment possibilities vary depending on the mode)



#### 4. Set advanced functions

Click Function (Func) in the lower left corner of the interface to enter the advanced settings.

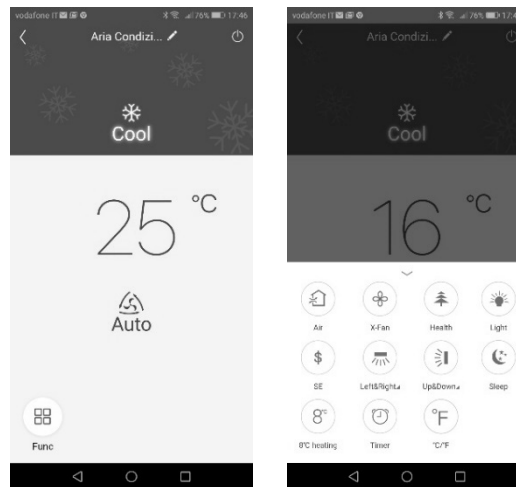

### X-FAN function

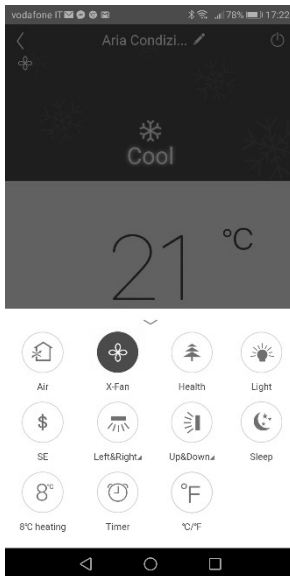

### Vertical flap swinging

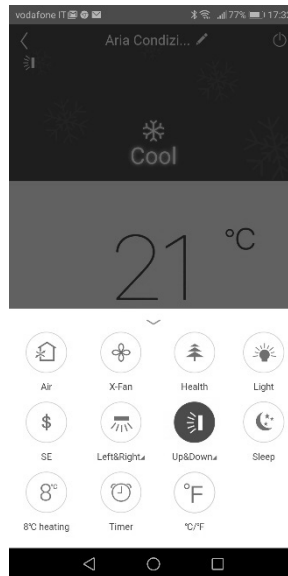

### Horizontal flap swinging (if available)

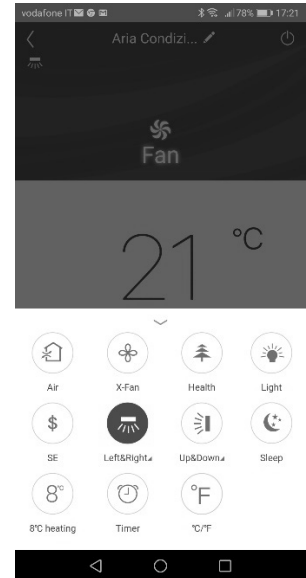

### Sleep function

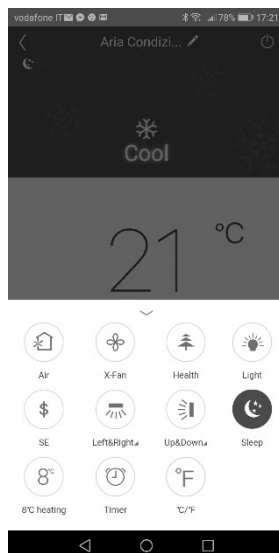

### Light on indoor unit display

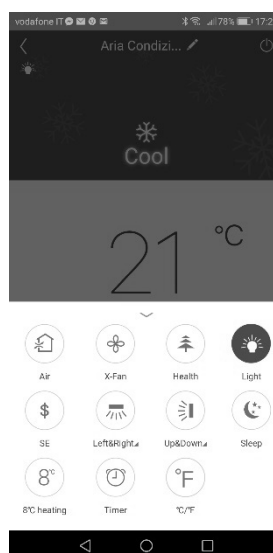

### Temperature unit conversion

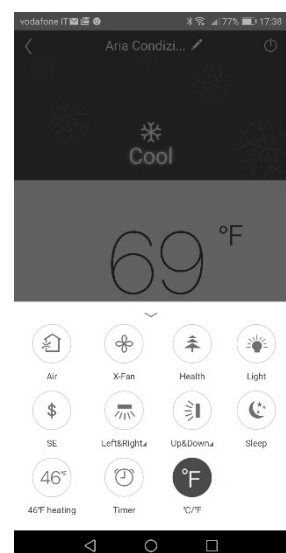

## Swing setting

Click Up & down swing to turn the swing function on or off. Click the arrow in the lower right corner of the icon to go to the next screen and set the swing level.



## List of Preselections

Click Timer. Then click + and make adjustments.

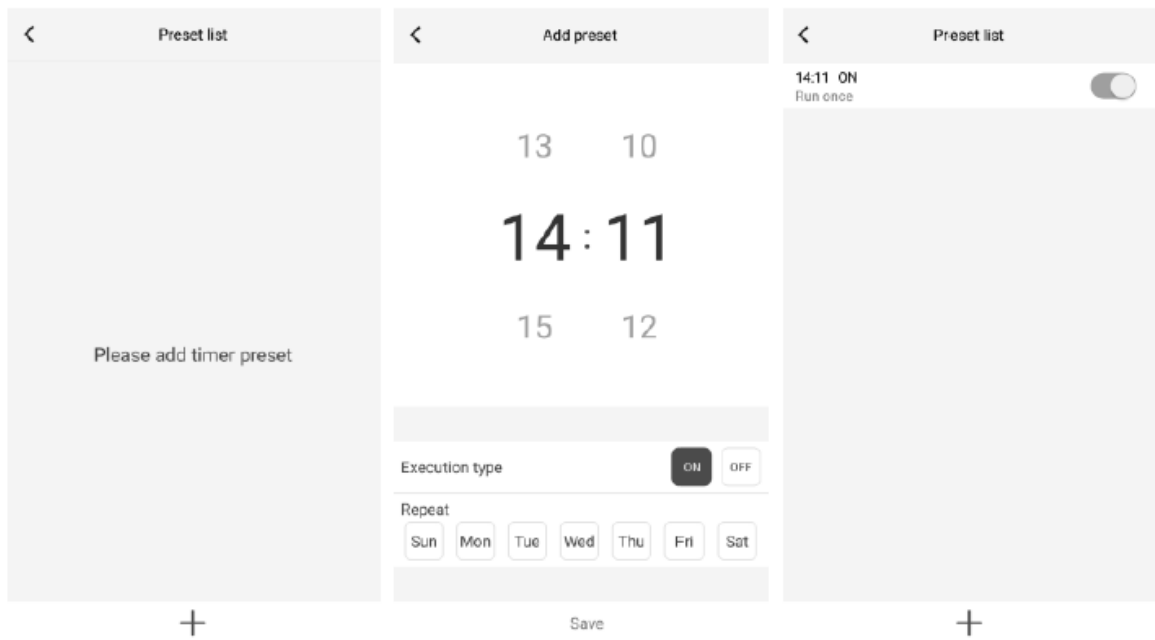

## Other functions

### 1. Homepage menu

Click on the profile  picture in the upper left corner of the homepage and set each menu function.

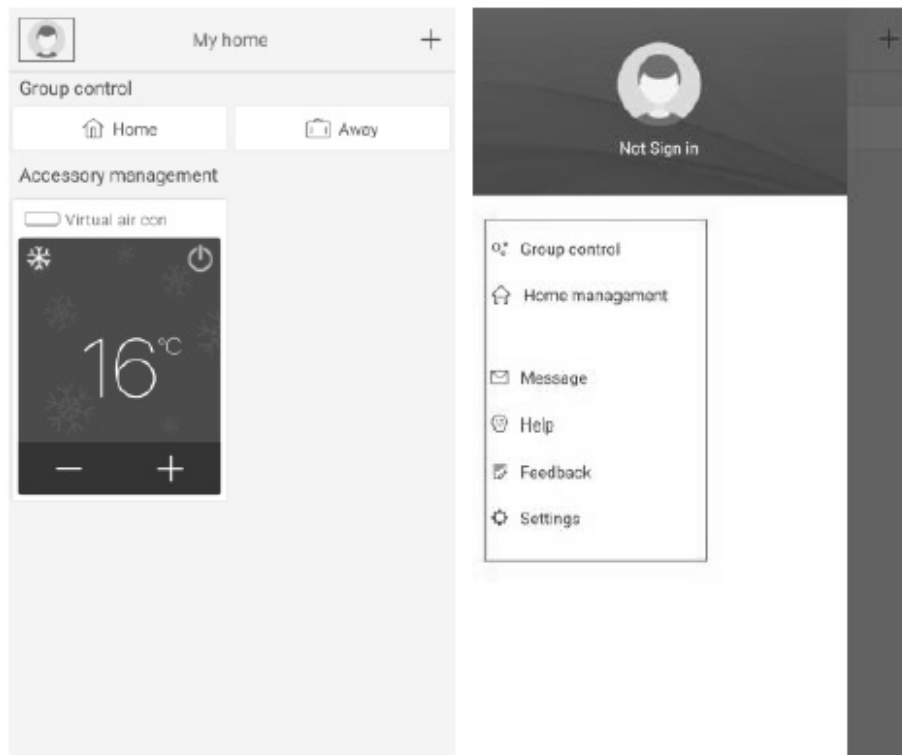

## 2. Group Control

Click Group Control to use the present devices (Ex. Change the group name to "hhh" and set up the devices in the group list). When this group is working you can change the settings of the whole group

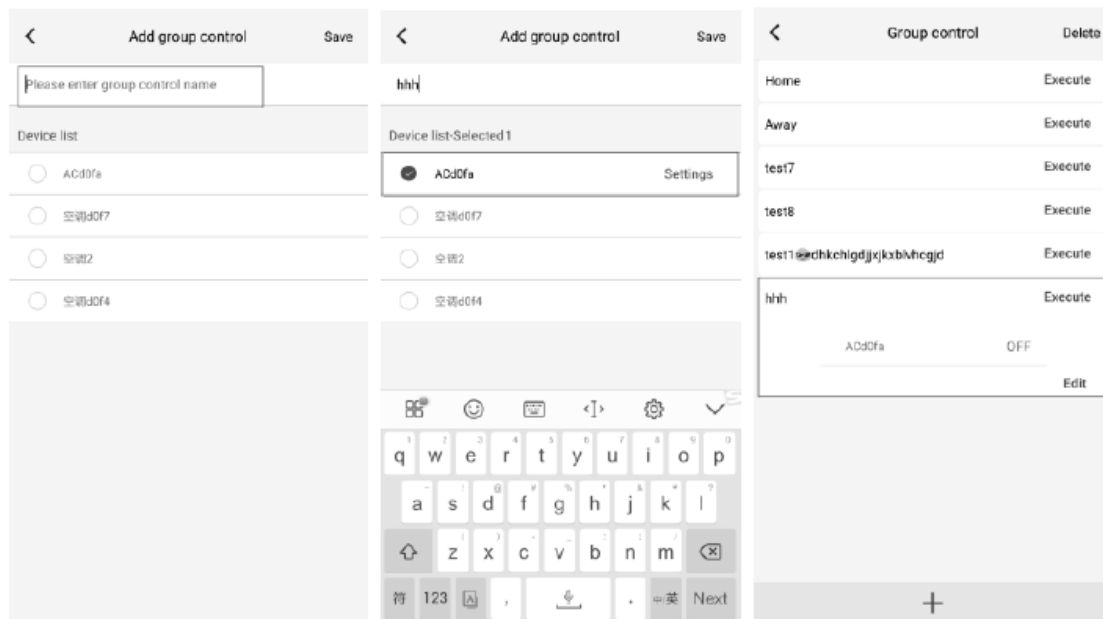

## 3. Home Management

Click Home Management to create or manage a "family system". You can add new members to the family system of the registered account.

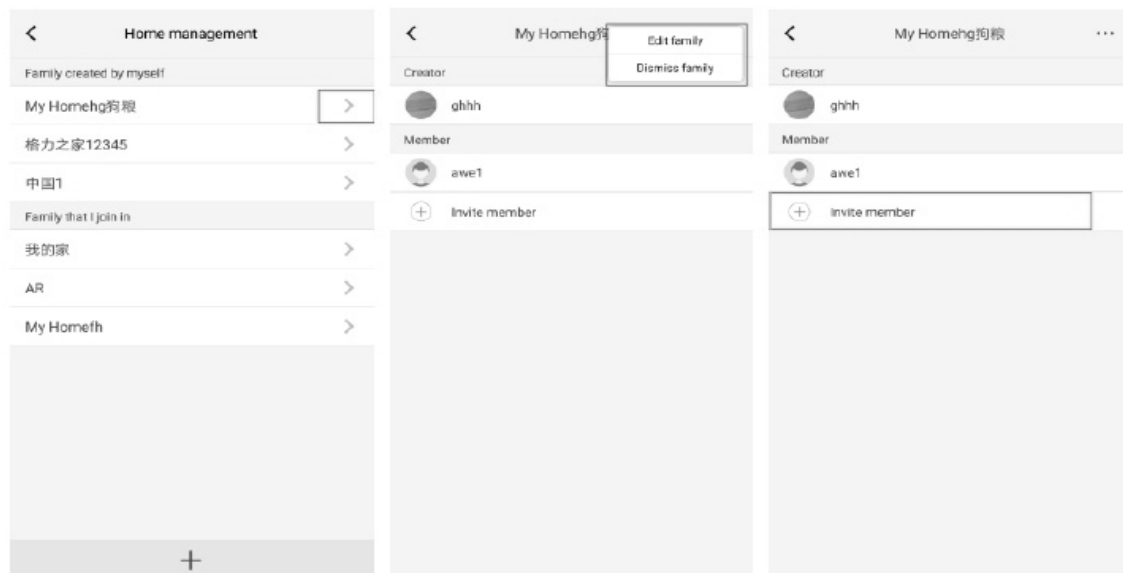

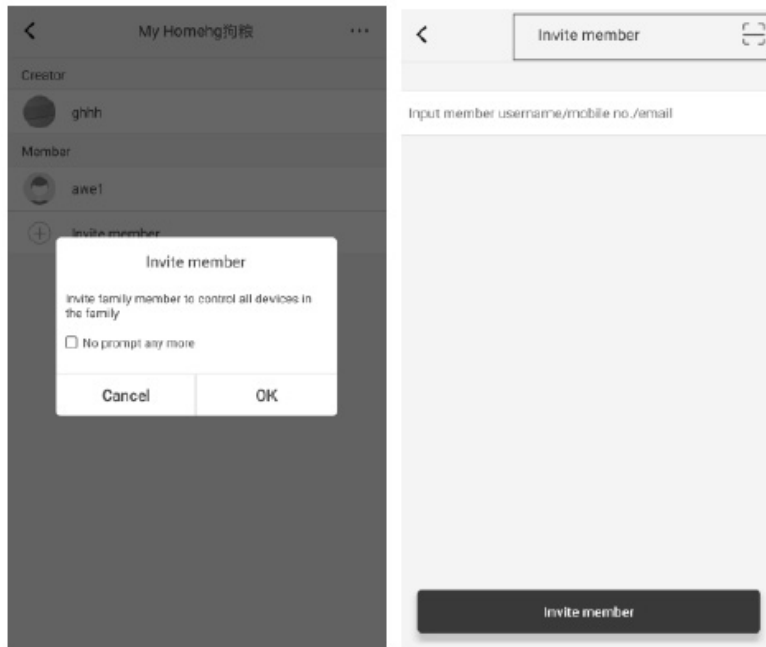

#### 4. Help

Press Help to view the instructions for **EWPE SMART APP**.

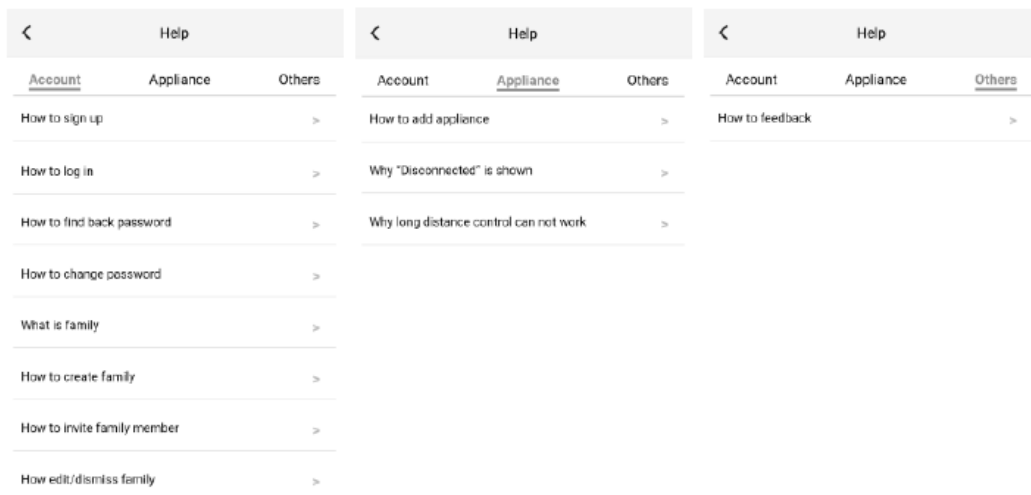

#### 5. Feedback

Clic Feedback to send a feedback on the product.

## 6. How to reset the air conditioner WiFi module:

Turn off the unit with the remote control and disconnect the air conditioner power for at least 10 seconds. Reconnect the power supply. After 1 minute, press the "WiFi" and "Mode" buttons simultaneously. If the air conditioner beeps, it means that the WiFi module has been reset correctly.

Attention: The configuration is carried out within 2 minutes. If it does not happen within 2 minutes, repeat the reset operation.

## Analysis of common network setting errors:

If the short distance control does not work, perform the checks specified below:

- Make sure the air conditioner power is connected.
- Make sure that the air conditioner's WiFi function is normally active.
- Make sure your phone's WiFi selects the corresponding air conditioner.
- Reset with the remote control and restart the setting from step 3.

It is important to remember what is listed below.

1. The WiFi function of the air conditioner takes about 1 minute to start.
2. The air conditioner is equipped with memory function.

## Emergency operation

In the event of loss or failure of the remote control, use the emergency button located under the indoor unit's front panel to turn the air conditioner on or off.

The unit will operate in automatic mode on start-up.

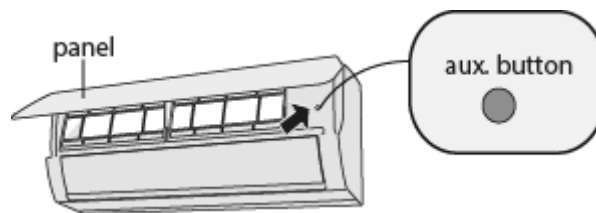

## MAINTENANCE

### Care and cleaning

**N.B.:**

**Disconnect the power before servicing or cleaning the unit.**

#### Cleaning the casing of the indoor unit

Use a soft, damp cloth to clean the outer surface of the unit.

Do not use water that is too hot, solvents, petrol or other aggressive chemical compounds, talcum powder or brushes. These may damage the colour or surface of the casing.

To remove stains, use warm water with a little neutral detergent.

Do not pour water onto the air conditioner to clean it. This may damage the internal components or cause a short circuit.

**N.B.:** Do not remove the panel when cleaning the unit.

## Cleaning the filters

### Open the panel

Lift the front panel of the indoor unit, as shown.



### Remove the filters

Remove the filters by lifting one of the bottom corners and pulling them downwards, as shown.

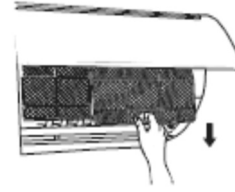

### Clean the filters

- Use a vacuum cleaner to clean the filters.
- If they are very dirty, use water (below 45°C) and leave to dry in a cool, dark place.

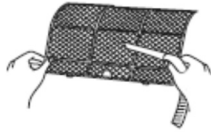

### Refit the filters

Refit the filters and close the front panel.



### N.B.:

- The filters should be cleaned every three months, or more frequently if the room is very dusty.  
**WARNING!**  
**When you remove the filters, avoid contact with the heat exchanger (there is a risk of cuts or abrasion).**
- Do not use a hairdryer to dry the filters; the heat can cause damage and warping.

## Before-use checks

1. Check that the air inlet and outlet are free of obstructions.
2. Check that the circuit breaker, plug and socket are in good working order.
3. Check that the filters are clean.
4. Check that the outdoor unit's support bracket is not damaged or corroded. If it is, contact the service centre.
5. Check that the piping is not damaged.

## After-use checks

1. Disconnect the power supply.
2. Clean the indoor unit's panel and filters.
3. Check that the outdoor unit's support bracket is not damaged or corroded. If it is, contact the service centre.

### N.B.

4. Many packaging materials are recyclable materials. Please dispose of them in the appropriate recycling unit.
5. If you want to remove the air conditioner, please contact your local dealer or local service provider for the correct disposal method.

## TROUBLESHOOTING

### Possible faults and solutions

#### WARNING

Do not attempt to repair the unit yourself. Improper repair can cause electric shocks or fire. Disconnect the unit from the power supply before contacting your local Technical Service Centre. Carry out the following checks before contacting your Technical Service Centre:

Fault	Check	Solution
The indoor unit does not receive the signal from remote control or the remote control does not seem to be working	Is there noticeable interference (e.g. static electricity, stable voltage)?	Pull out the plug. After about 3 minutes reinsert the plug and restart the unit.
	Is the remote control within the signal reception range? Are there any obstacles between the remote control and the receiver?	The maximum signal reception distance is 8 m. The remote control will not work beyond this distance. Remove the obstacles.
	Is the remote control pointed at the receiver?	Point the remote control at the receiver on the indoor unit.
	Is the remote control's sensitivity low? Are icons blurred or missing?	Check the batteries. If the batteries are very low, replace them.
	Do icons fail to appear on the display when you operate the remote control?	Check if the remote control is damaged. If it is, replace it.
	Is there a fluorescent light in the room?	Position the remote control next to the indoor unit. Turn off the fluorescent light and try again.
No air comes out of the indoor unit	Is the indoor unit's air inlet or outlet blocked?	Remove the obstruction.
	In heat mode, has the indoor temperature reached the set temperature?	Once the set temperature has been reached, the indoor unit will stop blowing out air.
	Has heat mode only recently been selected?	To prevent blasts of cold air from being blown out, there will be a delay of several minutes before operation begins (this is normal).
The air conditioner is not working	Is there a power cut?	Wait for the power to be restored.
	Has the plug come loose?	Reinsert the plug.
	Has the circuit breaker tripped or has the fuse blown?	Have the circuit breaker or fuse replaced by a qualified technician.
	Is the wiring faulty?	Have it replaced by a qualified technician.
	Was the unit restarted immediately after shutdown?	Wait 3 minutes and then restart the unit.
	Is the setting on the remote control correct?	Reset the function.
The indoor unit's air outlet produces a mist	Is the indoor temperature and humidity high?	Indoor air cools rapidly. Wait for the indoor temperature and humidity to fall and the mist to disappear.
The set temperature cannot be adjusted	Is the unit operating in automatic mode?	The temperature cannot be adjusted in automatic mode. Change the operating mode if you want to adjust the temperature.
	Does the desired temperature fall outside the available temperature range?	The available temperature range is: 16 – 30°C.
The desired level of heating/cooling cannot be achieved	Is the voltage too low?	Wait for the voltage to return to normal.
	Is the filter dirty?	Clean the filter.
	Does the set temperature fall within the available temperature range?	Adjust the temperature to within the available range.
	Are there any doors or windows open?	Close any doors and windows.
The unit is emitting unpleasant smells	Is there an odour source (e.g. furniture, cigarettes, etc.)?	Eliminate the odour source. Clean the filter.
The air conditioner turns on suddenly	Are there any sources of interference (e.g. lightning, wireless devices, etc.)?	Disconnect the power supply and then reconnect it. Turn the unit on again.
The outdoor unit produces steam	Has heat mode been selected?	Steam production when defrosting in heat mode is a normal phenomenon.

<b>Sound of running water</b>	Has the air conditioner recently been turned on or off?	The noise is produced by the refrigerant flowing inside the unit (normal phenomenon).
<b>Creaking/cracking noises</b>	Has the air conditioner recently been turned on or off?	It is the sound of the friction caused by the expansion and/or contraction of the panel or other parts due to temperature changes.

## Analysing faults and solutions

### Error codes

In the event of a fault, the temperature indicator on the indoor unit will flash to display the corresponding error code. Refer to the following list to identify the error code.

Error code	Faults and solutions
<b>E5</b>	Can be eliminated by turning the unit off and on again. Otherwise, contact a qualified technician for assistance.
<b>U8</b>	Can be eliminated by turning the unit off and on again. Otherwise, contact a qualified technician for assistance.
<b>E8</b>	Can be eliminated by turning the unit off and on again. Otherwise, contact a qualified technician for assistance.
<b>C5</b>	Contact a qualified technician for assistance.
<b>F1</b>	Contact a qualified technician for assistance.
<b>F2</b>	Contact a qualified technician for assistance.

N.B.: In the event of other error codes, contact a qualified technician for assistance.

## Warning

If you experience any of the following problems, turn the air conditioner off and immediately disconnect the power. Then contact your local Technical Service Centre.

- The power cable is damaged or has overheated.
- The unit makes an unusual noise during operation.
- The circuit breaker keeps tripping.
- The air conditioner emits a burning smell.
- The indoor unit is leaking.
- Do not attempt to repair or reinstall the air conditioner yourself.
- If the air conditioner is operated in abnormal conditions, malfunction, electric shock or fire may result.

# INSTALLATION INSTRUCTIONS

## Installation diagrams

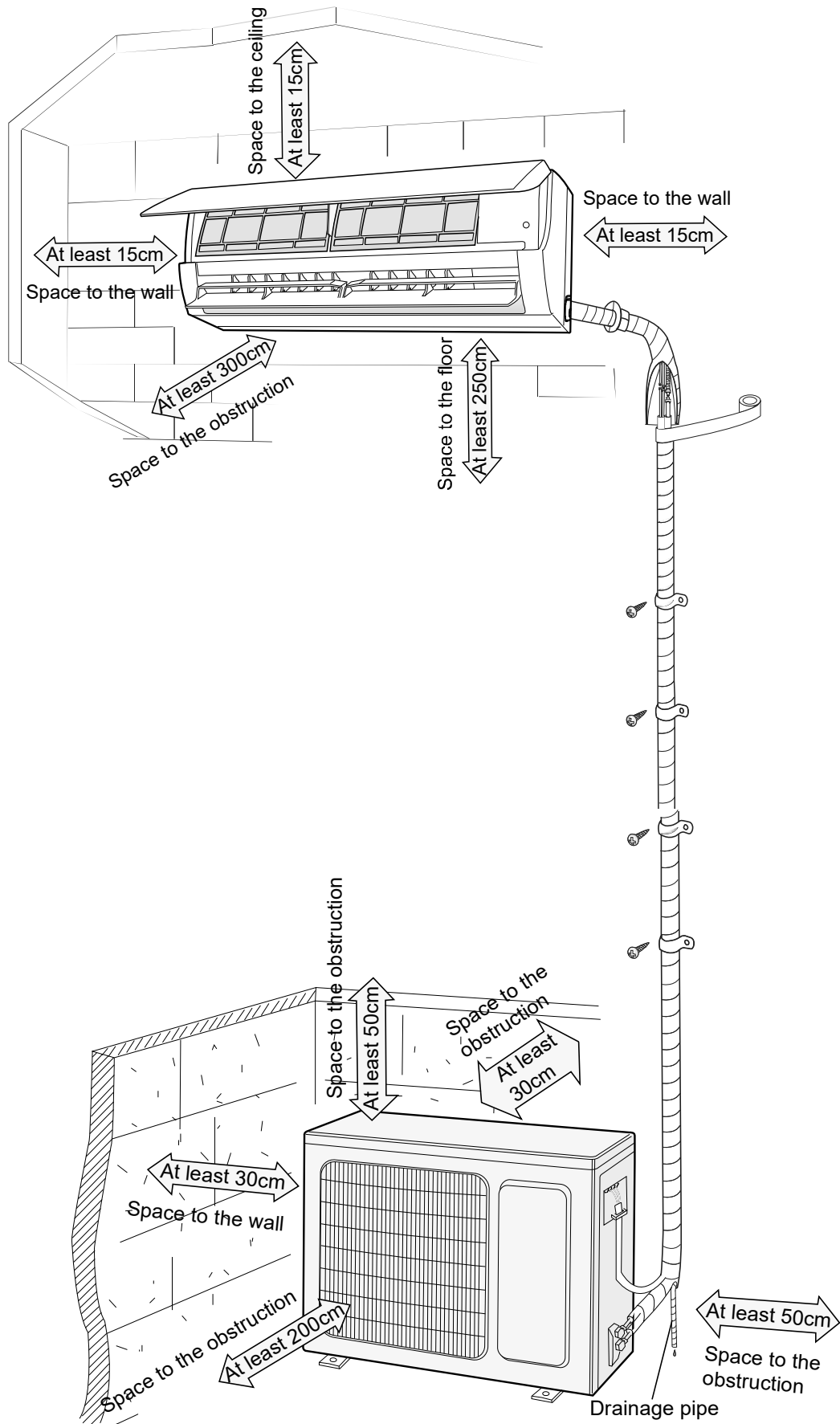



## INSTALLATION WARNINGS

**WARNING:** Make sure that the power supply is disconnected before carrying out any work on the unit.

**WARNING:** Wear appropriate personal protective equipment before carrying out any work on the unit.

**WARNING:** The appliance must be reinstalled in accordance with national system regulations.

**WARNING:** Wiring and installation must only be performed by a qualified technician trained to install, modify, extend and service the unit and perform safety and functionality tests.

**WARNING:** Install a device, master switch or electric plug that will allow all the power from the appliance to be switched off.

**WARNING:** Use only copper pipes for refrigerant connections.

**WARNING:** For the connection between the units, use only annealed and deoxidized copper pipe for conditioning and refrigeration and insulated with expanded polyethylene of min. 8 mm.

The following information is essential for correct unit installation. However, the installer should use his or her experience to install the unit according to specific requirements.

- Do not install the unit in locations where there are flammable gases or acid or alkaline substances that may irreparably damage the copper-aluminium heat exchangers or internal plastic components.
- Do not install the unit in offices or kitchens where oil vapours mixed with treated air may settle on the exchange coils, reducing performance, or on the unit's internal parts, damaging the plastic components. When installing or relocating the unit, be sure to keep the refrigerant circuit free of air or substances other than the specified refrigerant.
- Any presence of air or other foreign matter in the refrigerant circuit will cause increased system pressure or compressor failure, resulting in damage.
- When installing or relocating the unit, do not charge refrigerant that does not conform to that indicated on the nameplate or unidentified refrigerant. Otherwise, it may cause abnormal operation or an accident.
- When refrigerant needs to be recovered, in case of transfer or repair of the unit, make sure the unit is operating in cooling mode. Then, completely close the valve on the high pressure side (liquid valve). Approximately 30-40 seconds later, completely close the valve on the low pressure side (gas valve), stop the unit immediately and disconnect the power supply. The time for refrigerant recovery should not exceed 1 minute.
- If refrigerant recovery takes too long, air can be sucked in and cause pressure increase or compressor failure, resulting in injury.
- During refrigerant recovery, ensure that the liquid valve and gas valve are completely closed and the power supply is disconnected before disconnecting the connecting pipe.
- If the compressor starts to operate when the shut-off valve is open and the connecting pipe is not connected, the air will be drawn in and will cause the pressure to rise or the compressor to break, resulting in injury.
- When installing the unit, make sure that the connecting pipe is firmly connected before the compressor starts to run.
- Prohibit installation of the unit where there may be a leak of corrosive gas or flammable gas.
- In case of gas leaks from the unit, explosions and other accidents may occur.
- Do not use extension cables for electrical connections. If the electric cable is not long enough, please contact an authorized local service center and ask for an appropriate electric cable.
- Inadequate wiring can cause electric shock or fire.

- Use the specified cable types for electrical connections between indoor and outdoor units. Securely lock the cables so that their terminals do not receive external stress.
- Electric cables with insufficient capacity, incorrect cable connections and insecure cable terminals may cause electric shock or fire.

## Choosing a location for installation

Essential requirements	Indoor unit
<p>Do not install the unit in the following locations. Otherwise, a fault may occur.</p> <ol style="list-style-type: none"> <li>1. Locations with extreme heat sources or flammable or explosive gases or vapours.</li> <li>2. Locations with high-frequency devices (e.g. welding machines, medical equipment).</li> <li>3. Locations close to coastal areas.</li> <li>4. Locations with oils or fumes in the air.</li> <li>5. Locations with sulphide gas.</li> <li>6. Other locations that have special conditions.</li> </ol> <p>Do not operate the unit in the immediate vicinity of laundrettes, bathtubs, showers or swimming pools.</p>	<ol style="list-style-type: none"> <li>1. There should be no obstructions near the air inlet or outlet.</li> <li>2. Choose a location where the condensate can drain out easily without causing a nuisance.</li> <li>3. Choose a convenient location to connect the outdoor unit to the power outlet.</li> <li>4. Choose a location out of the reach of children.</li> <li>5. The site should be strong and solid enough to support the weight of the indoor unit and prevent noise or vibration.</li> <li>6. The unit should be installed 2.5 m from the floor.</li> <li>7. Do not install the indoor unit directly above electrical equipment.</li> <li>8. Try to keep a certain distance from fluorescent lights.</li> </ol>
Outdoor unit	
<ol style="list-style-type: none"> <li>1. Choose a location where the noise and airflow produced by the outdoor unit will not annoy neighbours.</li> <li>2. The location should be well ventilated and dry; the outdoor unit must not be exposed to direct sunlight or strong winds.</li> <li>3. The site should be able to support the weight of the outdoor unit.</li> <li>4. Check that the installation complies with the requirements of the dimensional drawing for installation.</li> <li>5. Choose a location out of the reach of children and away from animals or plants. If this is not possible, install safety fencing.</li> </ol>	

## Electrical connection requirements

### Safety precautions

1. Electrical safety standards must be met when installing the unit.
2. Use a power supply circuit and circuit breaker that comply with local safety regulations.
3. Make sure that the power supply matches the requirements of the air conditioner. An unstable power supply or incorrect wiring may result in a fault. Install suitable power cables before switching on the air conditioner.
4. Correctly connect the live, neutral and earth wires to the power outlet.
5. Disconnect the power supply before carrying out any work on the electrical circuit or carrying out any safety work. For models with a plug, make sure the plug is easily accessible after installation.
6. Do not connect the power before installation is complete.
7. Do not use the appliance if the power cable or plug are damaged. If the power cable is damaged it must be replaced by the manufacturer, retailer or other qualified person to avoid a hazard.
8. Since the temperature of the cooling circuit is high, keep the interconnecting cable away from the copper pipe.
9. The unit must be installed in accordance with national wiring regulations.
10. Installation must only be performed by trained individuals in accordance with regulations.



The unit is charged with a slightly inflammable refrigerant, R32. Improper handling of this gas may expose people and materials to serious damage. More details on this refrigerant are given at the beginning of this manual.

## Earthing

1. The air conditioner is a Class I appliance. The unit must be earthed with an appropriate device by a qualified technician. Ensure the unit is always properly earthed. Otherwise electric shock may result.
2. The green-yellow wire of the air conditioner is the earthing wire and may not be used for other purposes.
3. The earth resistance must meet national standards for electrical safety.
4. The unit must be positioned so that the plug is accessible.
5. An all-pole isolating switch with a minimum contact gap of 3mm in each pole must be connected to the fixed cable.
6. Insert a switch with sufficient power and observe the following table. The air switch must include a magnetic and thermal function for protection against short circuits and overloads. (Warning: do not use only the fuse to protect the circuit).

Air conditioner	Switch current power
18K	16A
21-24-28-36-42K	25A

## INSTALLATION

### Indoor unit installation

#### Step one: choose of indoor unit position

Decide where to install the unit based on room design, architectural limitations and customer requirements. Check that in the selected location the unit can be accessed for servicing and cleaning the filters. To install, use the installation plate as a template to identify the exact position for the wall plugs and through-hole in the wall. The plastic casing has stoppers which if necessary can be removed to route the refrigerant lines and cables. When operating in cool or dry mode, the moisture in the air condenses on the coil of the indoor unit, collects in the basin and drains out through the special rubber hose. The hose must be connected to a pipe with a suitable gradient, ensuring no unnecessary bends are created. Do not run siphons and do not immerse in water.

#### Step two: mount the wall-installation plate

1. Position the installation plate on the wall. Use a level to position it horizontally and mark the holes for the bolts on the wall.
2. Drill the holes for the screws in the wall with a hammer drill (the drill bit must match the plastic wall plug). Then insert the wall plugs into the holes.
3. Secure the plate to the wall with the self-tapping screws (ST4.2X25TA). Check it is securely attached by pulling on the bracket. If a plastic wall plug is loose, drill another hole nearby with the hammer drill.

#### Step three: drill the hole for the piping

Select the position for the piping hole according to the direction of the outlet pipe. The piping hole must be slightly lower than the wall-installation frame, as shown below.

9K

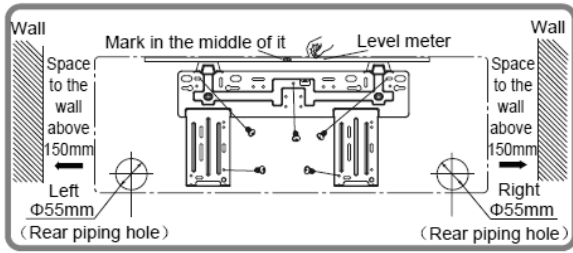

12K

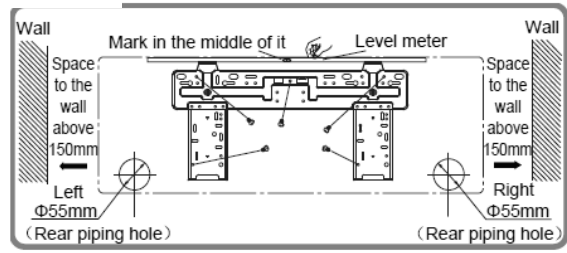

18K

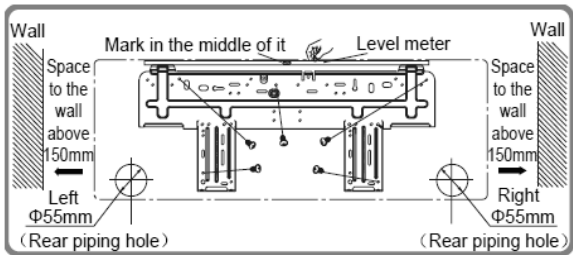

24K

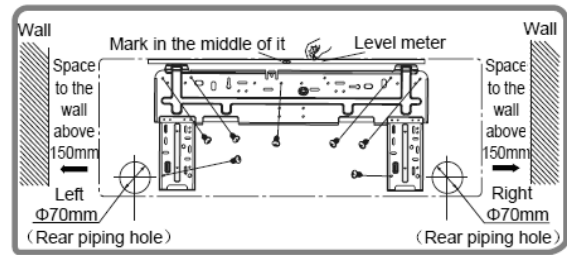

Drill a piping hole of diameter  $\Phi 55$  or  $\Phi 70$  at the chosen location for the outlet pipe. To allow for proper drainage, the piping hole in the wall must slant slightly downwards to the outdoor side, with a gradient of  $5 - 10^\circ$ .

Piping hole	Model
$\Phi 55$	Cooling capacity < 6000 W

**N.B.:**

- Take the necessary safety measures when drilling the hole and do not allow dust to enter.
- The plastic wall plugs are not supplied but must be purchased on site.

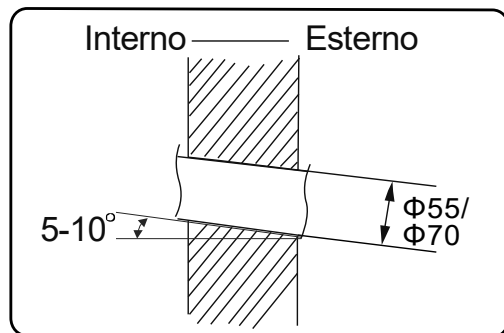

	Indoors
	Outdoors

**Step four: outlet pipe**

The pipe can be brought out in various different directions: right, rear right, left or rear left.

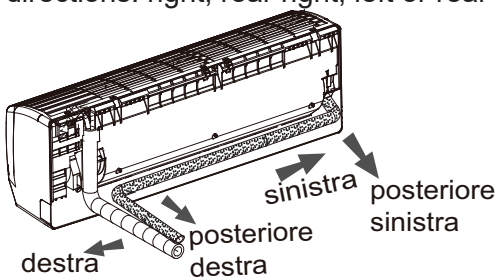

destra	right
Posteriore destra	rear right
sinistra	left
Posteriore sinistra	rear left

Once you have selected the direction of the outlet (left or right), drill the corresponding hole at the bottom.

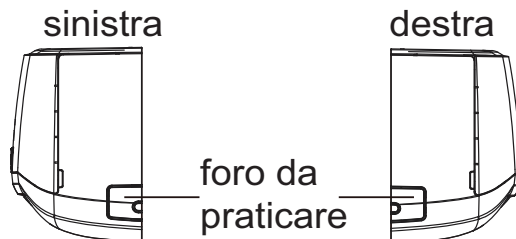

destra	right
foro da praticare	hole to be drilled
sinistra	left

### Step five: connect the indoor unit pipe

Position the pipe joint in the corresponding bellmouth.

Pre-tighten the union nut by hand.

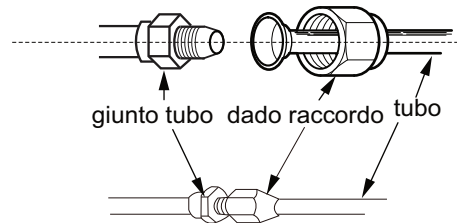

giunto	pipe
tubo	joint
dado	union
raccordo	nut

Adjust the torque according to the following table. Position the open-end spanner on the pipe joint and position the torque wrench on the union nut. Tighten the nut with the wrench.

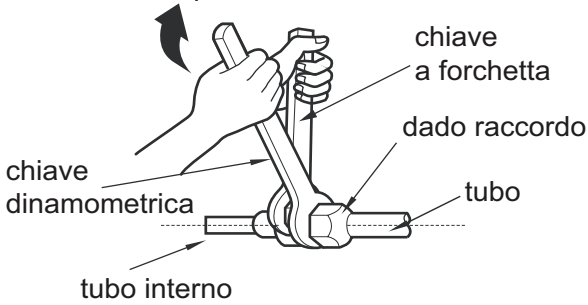

Hex nut diameter	Tightening torque (Nm)
$\Phi 6.35$	15 – 20
$\Phi 9.52$	35 – 40

chiave a forchetta	open-end spanner
chiave di namometrica	wrench
tubo interno	inner pipe
dado raccordo	union nut
tubo	pipe

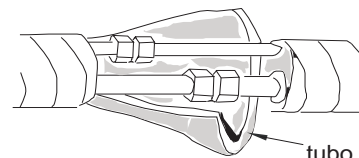

tuboisolante	insulating tube
--------------	-----------------

Wrap the indoor pipe and the joint of the connecting pipe with an insulating tube. Then wrap with tape.

### Step six: install the condensate drain pipe

Connect the drain pipe to the outlet pipe of the indoor unit.

Bind the joint with tape.

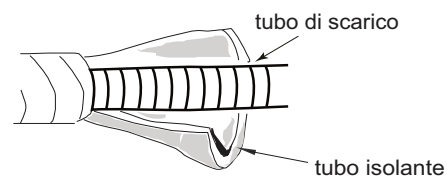
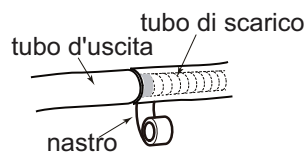
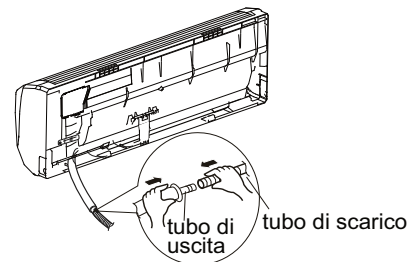

tuboisolante	insulating tube
tubo di uscita	outlet pipe
tubo di scarico	drain pipe
nastro	tape

N.B.:

- Add an insulating tube to the indoor drain pipe to prevent condensation.
- The plastic wall plugs are not supplied.

## Step seven: connect the indoor unit electrical cable

1. Open the panel. Remove the screw that secures the small panel covering the terminal board.

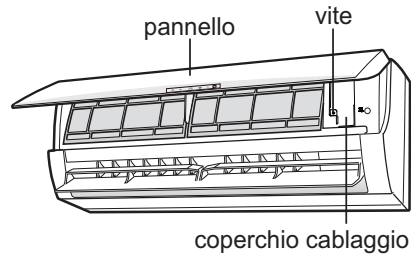

2. Insert the indoor and outdoor unit connecting cable into the rear hole corresponding to the terminal block. Then pull it out of the front.

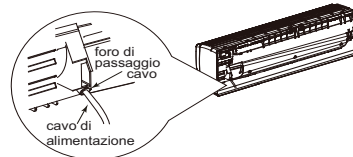

pannello	panel
vite	screw
coperchio cablaggio	wiring cover
foro di passaggio	cable
cavo	through-hole
cavo di alimentazione	power cable

6. Remove the cable clip. Connect the power cable to the terminal block according to colour. Tighten the screw and secure the power cable with the clip.

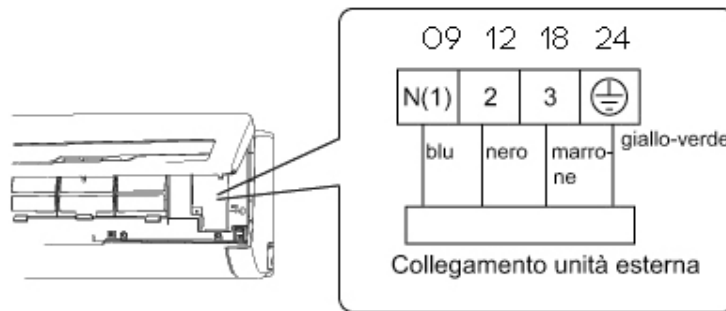

blu	blue
nero	black
marrone	brown
giallo-verde	yellow-green
collegamento unità esterna	Outdoor unit connection

4. Reposition the terminal block cover and tighten the screws.

5. Close the panel.

### N.B.:

- All wiring must be connected as shown on the unit's wiring diagram. All indoor and outdoor unit cables must be connected by a qualified technician.
- If the power cable is not long enough, contact the supplier for a new one. Do not attempt to extend it yourself.
- For air conditioners equipped with a plug, the plug must be easily accessible upon completion of installation.
- For air conditioners without a plug, install a circuit breaker on the line. The circuit breaker must be single-pole and the contact gap must be greater than 3mm.

## Step eight: bind the pipes

1. Bind together the connecting pipe, the power cable and the drain pipe with binding tape.

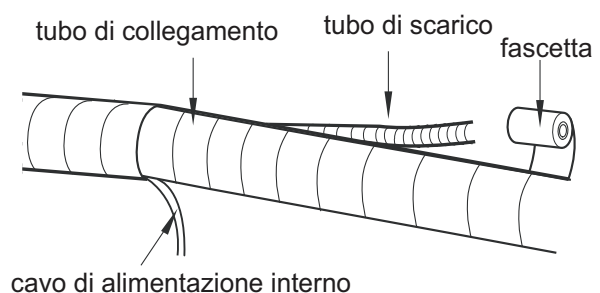

tubo di collegamento	connecting pipe
tubo di scarico	drain pipe

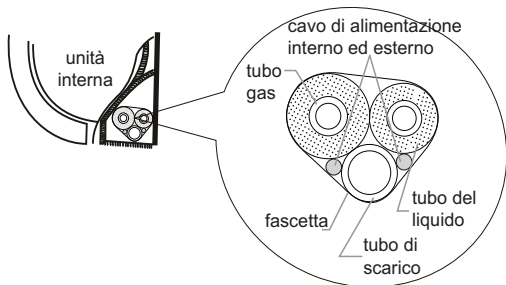

fascetta	binding tape
cavo di alimentazione interno ed esterno	Indoor powercable

unità interna	indoor unit
cavo di alimentazione interno ed esterno	indoor and outdoor power cable
tubo gas	gas pipe
fascetta	binding tape
tubo di scarico	drain pipe
tubo del liquido	liquid pipe

2. Reserve a section of the drain pipe and power cable for installation when binding. When you have bound up to a certain point, separate the indoor power cable and then the drain pipe.

3. Bind them evenly.  
4. The liquid pipe and gas pipe must be bound separately at the end.

**N.B.:**  
**The power cable and signal control cable must not be rolled or coiled.**  
**The drain pipe must be bound at the bottom.**

### Step nine: hang the indoor unit

1. Insert the bound pipes into the wall pipe and route them through the hole in the wall.
2. Hang the indoor unit on the wall-installation plate.
3. Fill the gap between the pipes and the hole in the wall with sealant.
4. Secure the wall pipe.
5. Check that the indoor unit is securely installed and flush against the wall.

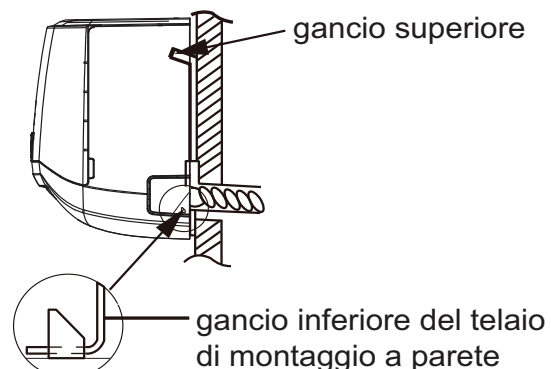
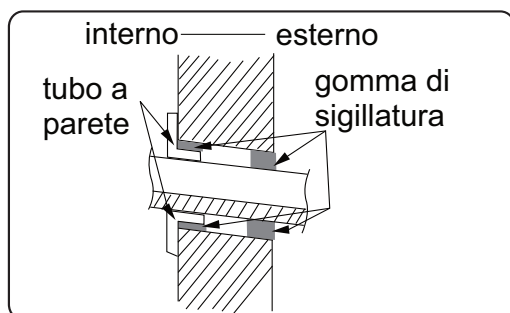

interno	indoors
esterno	outdoors
tubo a parete	wall pipe
gomma di sigillatura	rubber sealant
gancio superiore	upper hook
gancio inferiore del telaio di montaggio a parete	lower hook of wall-installation frame

**N.B.** Avoid bending the drain pipe too much in order to prevent clogging.

## Outdoor unit installation

For all connections refer to the wiring diagrams supplied with the unit. If the outdoor unit was connected to a higher level than the one of the indoor unit, you must make a siphon. The outdoor unit must be installed outdoors, in a perfectly horizontal position, respecting the minimum distances to allow the air to flow and the execution of any maintenance. The unit is built with resistant materials to protect it from any weather condition so it's not necessary to protect it in a particular way. Make sure however that the heat exchanger is not exposed to the danger of hail. If you want to attach the unit to a wall, use brackets appropriately sized to support the weight of the unit. Condensation produced due to the operation in heating can be piped to a drain using the appropriate predisposition.

## Handling the unit



After unpacking make sure that the content is intact and complete



The handling of the product must be made by qualified and prepared personnel, who are supplied with suitable equipment made to support the weight of the product.



The outdoor unit must always be kept upright.

## Installation diagram and technical spaces



The installation should be performed by qualified service personnel and experienced, reliably and in compliance with this manual.



Contact your service centre prior to installation to prevent malfunction due to a unprofessional installation.



In taking and moving the units it is necessary to be guided by qualified and experienced people.



Make sure there is plenty space around the unit.

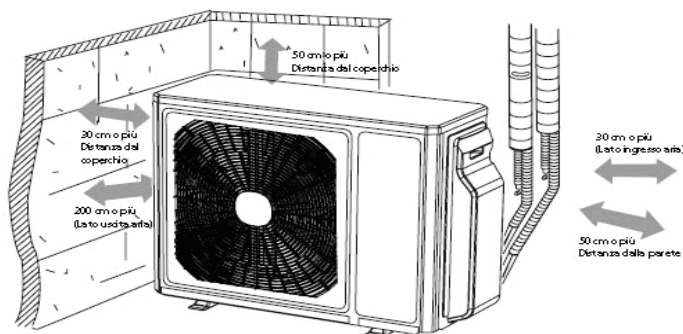

### Collocation



Use bolts to secure the unit to the floor, which must be a solid ground. When installing the unit on the wall or on the roof, make sure the support is firmly secured so that it cannot move in the event of severe vibration or high winds.

**Warning: The installation must be performed in compliance with NEC/CEC rules by authorized personnel only.**

•Do not install the outdoor unit in cavities or air vents.

Install junction and drain hose (only for models with heat pump)

When the unit is in heating mode it produces condensation, which flows from the outdoor unit. In order not to disturb neighbors and to respect the environment, install a fitting and a drain hose that can steer the condensation water. Install the discharge fitting and the rubber gasket on the frame of the outdoor unit and connect a drain hose as shown in figure.

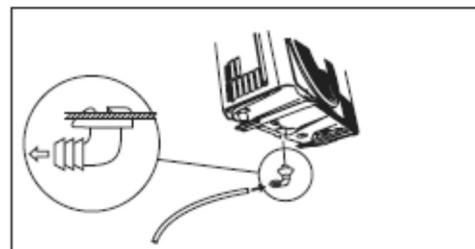

### Refrigerating connections



Use equipment and connecting pipes suitable for R32 refrigerator.



MODELS	18	21	24	28	36
Pipes lenght with a standard refrigerating charge	10	30	30	40	40
Maximum pipes lenght with additional charge	20	60	60	70	75

- If the pipes with a cap until the connection is completed. Be sure not to let anything in the pipes or in the system, such as dirt, water, etc.
- The piping connected to the indoor and outdoor unit must be new. Required thickness of pipes is 0.8 mm or more.
- Only use R32 refrigerant in line with the one already loaded in the outdoor unit to fill the refrigerant in the system.



Maximum pipes length per unit	10	20	20	20	20
Additional charge g/m	20	20	20	20	20



**Always write the additional refrigerant charge on the data label affixed to the unit outside.**

**The maximum height difference between indoor and outdoor unit is 5m.**



Wrap with straps all refrigerant pipes and joints.



Tighten connections using two keys operated in opposite directions.

- **Additional charge of refrigerant and oil**
- If the length of the connecting pipe is increased by 10 m compared to the standard length, add 5 ml of refrigerant oil for every 5 m of pipe added.
- Method for calculating the amount of additional refrigerant charge (liquid pipe):  
amount of additional refrigerant charge = additional length of pipe liquid x amount of additional refrigerant charge per meter.

## Vacuum pump

Humid air left inside the refrigerant circuit can cause compressor malfunction. After having connected the indoor and outdoor units, bleed the air and humidity from the refrigerant circuit using a vacuum pump.

- (1) Unscrew and remove the caps from the 2-way and 3-way valves.
- (2) Unscrew and remove the cap from the service valve.
- (3) Connect the vacuum pump hose to the service valve.
- (4) Operate the vacuum pump for 10-15 minutes until an absolute vacuum of 10 mm Hg has been reached.
- (5) With the vacuum pump still in operation, close the low-pressure knob on the vacuum pump coupling. Stop the vacuum pump.
- (6) Open the 2-way valve by 1/4 turn and then close it after 10 seconds. Check all the joints for leaks using liquid soap or an electronic leak device.
- (7) Turn the body of the 2-way and 3-way valves. Disconnect the vacuum pump hose.
- (8) Replace and tighten all the caps on the valves.

Diameter (mm)	Twisting moment (N.m)
Φ6,35	15-20
Φ9,52	35-40

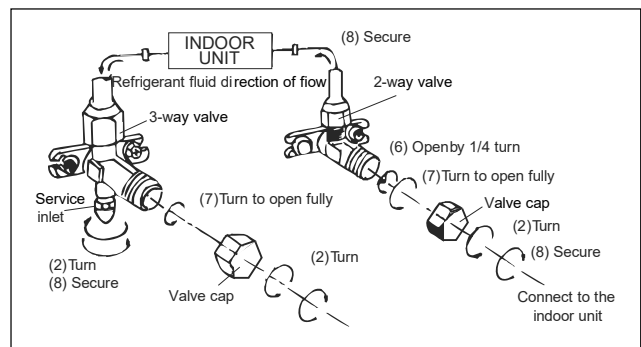
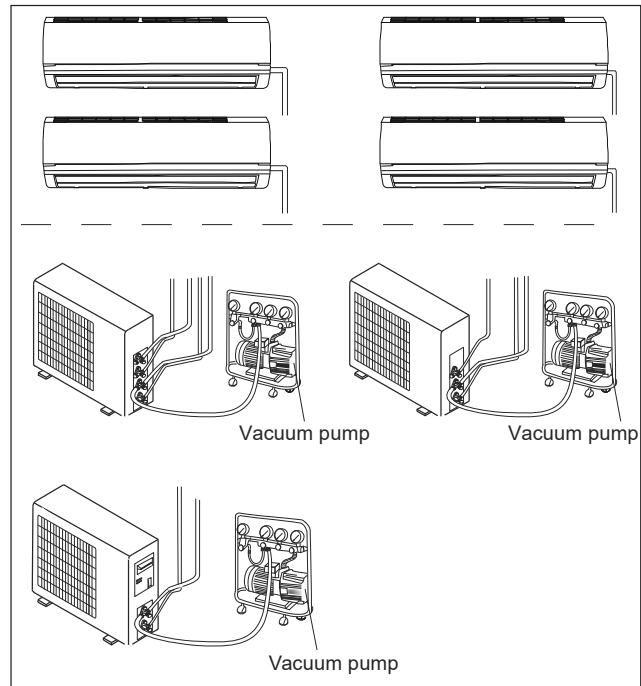

## Maintenance



Only use adequate equipment for the R32 refrigerant

**Do not use a different refrigerant from R32.**



Do not use mineral oils to clean the unit.

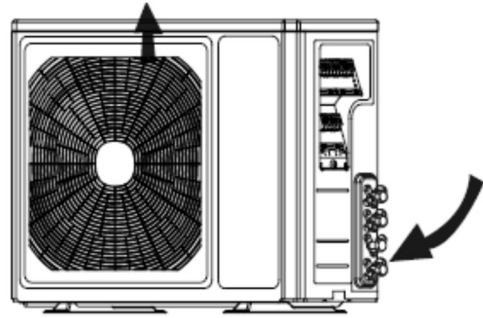

## Electrical connections

1. Remove the cover of the terminal block on the right side of the outdoor unit. (one screw)
2. Connect the wires to the unit as shown in the figure, make sure that each cable is properly connected to the terminal boards of the two units.
3. Reassemble the cover of the terminal



Insert a magneto thermic switch with sufficient power and observe the following table:

Power circuit breaker
<b>18K – 16A</b>
<b>21K / 24K / 28K / 36K / 42K – 25A</b>

	To protect the unit against short circuits, mount on the power line a magneto thermal omni polar switch (IG) curve C 250V with a minimum contact opening of 3mm.
	Wrong connection of cable may cause malfunctions of the electrical components. Once fixed the cables, make sure that the lines between the links and the fixing point are separated by some space
	The connection pipes and connection cables of units A and unit B must correspond to each other.
	The device must be installed in accordance with national regulations of wiring.

**X3MI ECO 52SH**

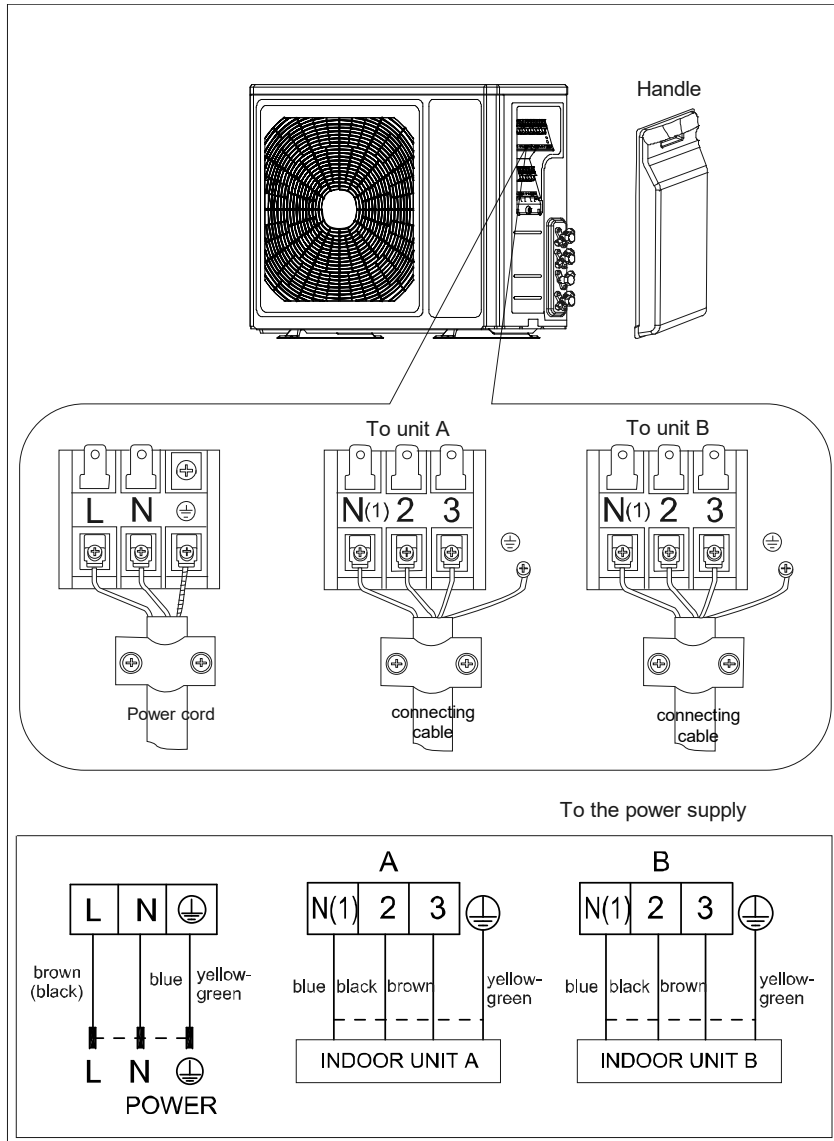

# X3MI ECO 61SH

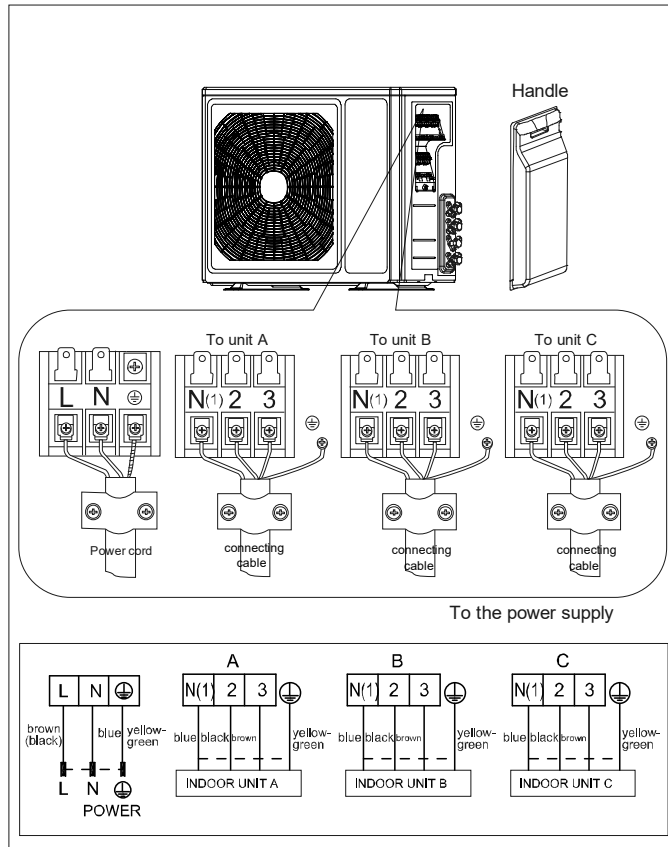

# X3MI ECO 71SH

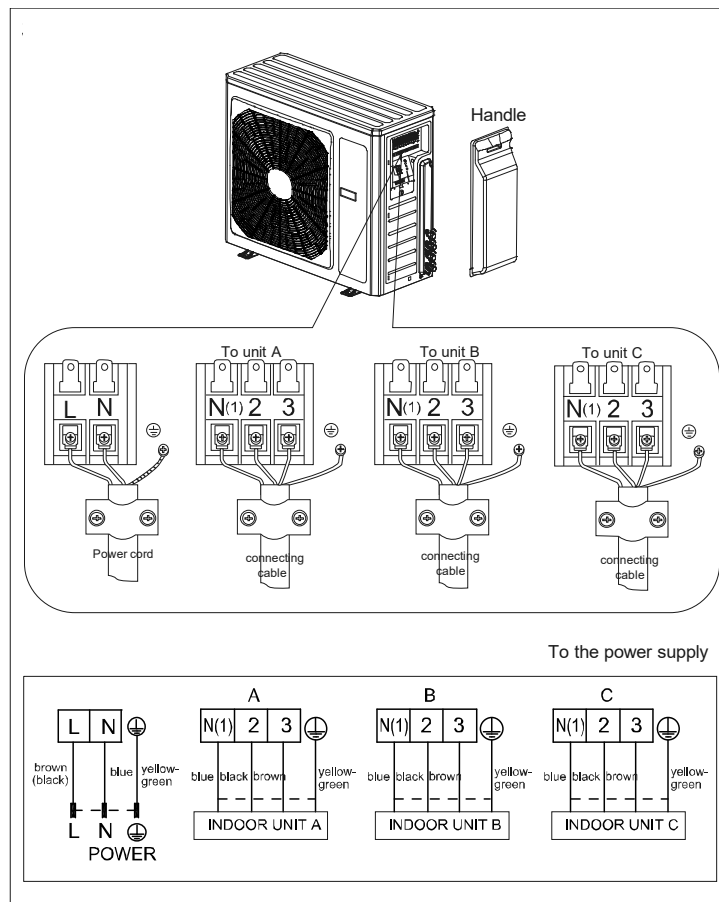

# X3MI ECO 80SH - X3MI ECO 105SH

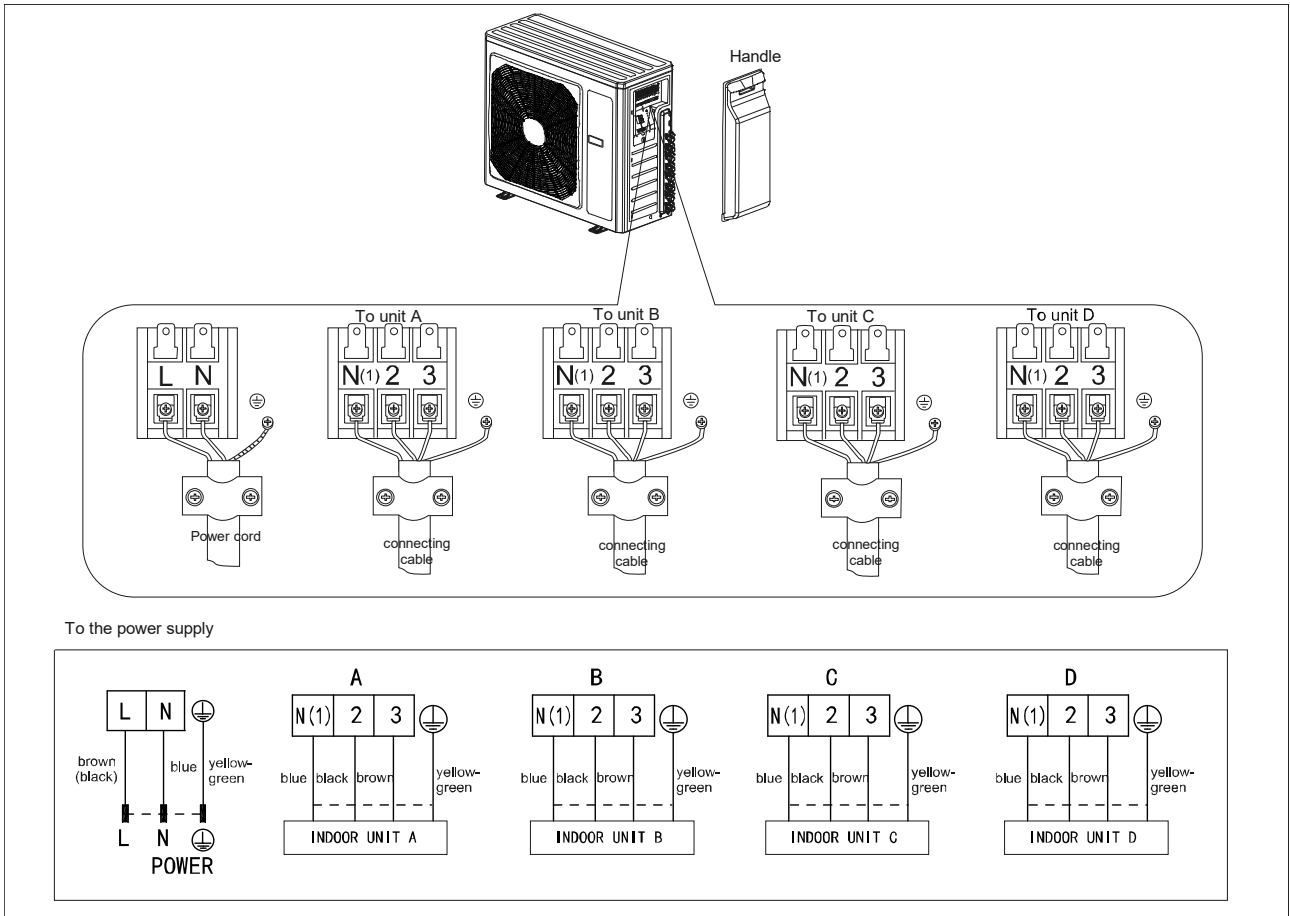

# X3MI ECO 120SH

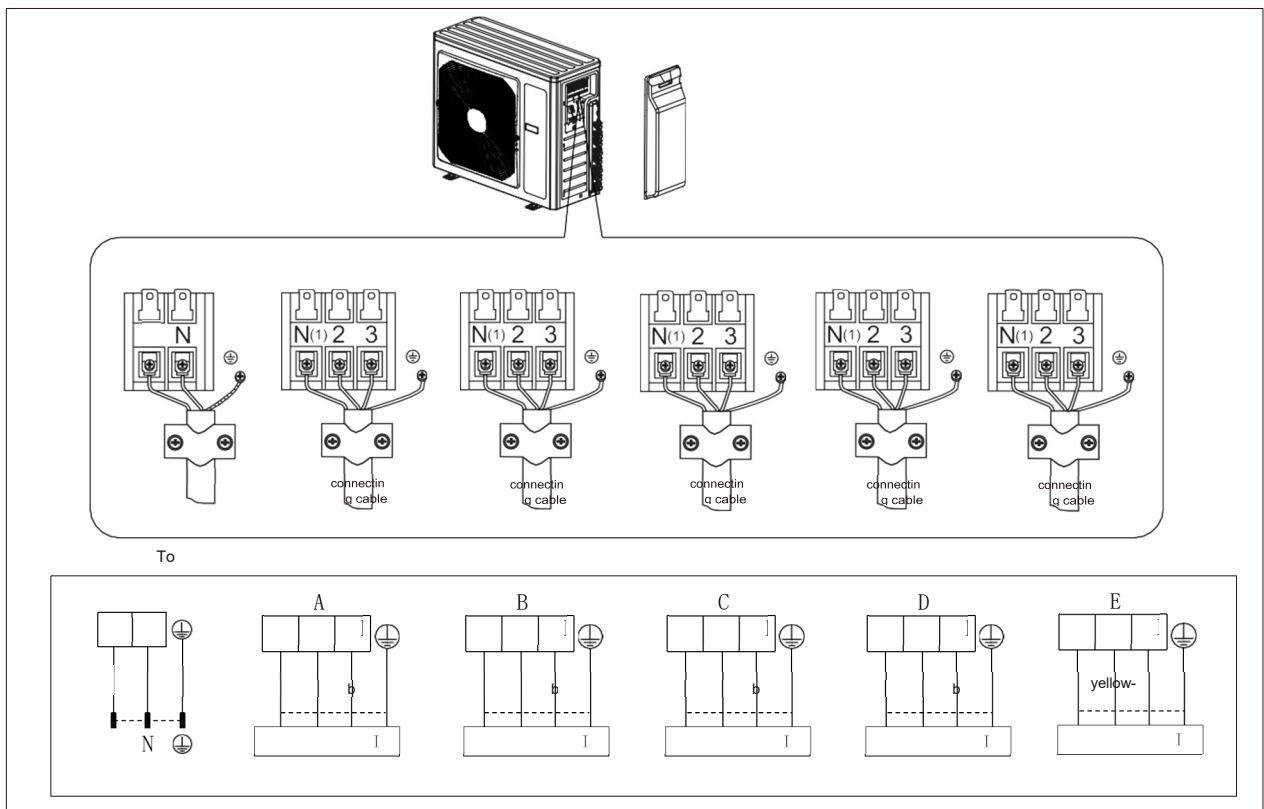

## Post-installation checks

Checks	Possible fault
Has the unit been installed securely?	The unit could fall, move or produce excessive noise.
Is the thermal insulation of the pipes sufficient?	Risk of condensation and dripping water.
Has the check for gas leaks been executed?	Risk of cooling (heating) not satisfactory.
Does the water drain properly?	Risk of condensation and dripping water.
Does the supply voltage match the voltage indicated on the data plate?	Risk of malfunction or damage to components.
Have the piping and electrical wiring been installed correctly?	Risk of malfunction or damage to components.
Has the unit been properly earthed?	Risk of electric leakage.
Does the power cable meet requirements?	Risk of malfunction or damage to components.
Are there any obstructions at the air inlet or outlet?	The cooling (heating) capacity may be insufficient.
Have the dust and other particles produced during installation been removed?	Risk of malfunction or damage to components.
Are the gas valve and liquid valve of the connecting tube fully open?	The cooling (heating) capacity may be insufficient.
Have the length of the refrigerating tube and the amount of the refrigerant charge been registered?	It is not easy to decide the amount of the refrigerant charge to add.

## Safety operation of flammable refrigerant

### Qualification requirement for installation and maintenance

- All workers who engage with the refrigeration system should bear the valid certification awarded by the authoritative organization, and the qualification recognized by the industry for dealing with the refrigeration system.
- The refrigeration system can only be repaired following the methods suggested by the equipment's manufacturer.

### Installation notes

- The air conditioner mustn't be used in a room that has running fire or heat sources (such as, working coal gas ware, operating heater).
- Do not drill holes in the circuit or burn the connection pipe.
- The air conditioner must be installed in a room that is larger than the minimum room area. The minimum room area is shown on the following "table a".
- Leak test is mandatory after installation.

table a - Minimum room area ( m<sup>2</sup>)

Minimum room area( m <sup>2</sup> )	Charge amount (kg)	≤1.2	1.3	1.4	1.5	1.6	1.7	1.8	1.9	2	2.1	2.2	2.3	2.4	2.5
	floor location	/	14.5	16.8	19.3	22	24.8	27.8	31	34.3	37.8	41.5	45.4	49.4	53.6
	window mounted	/	5.2	6.1	7	7.9	8.9	10	11.2	12.4	13.6	15	16.3	17.8	19.3
	wall mounted	/	1.6	1.9	2.1	2.4	2.8	3.1	3.4	3.8	4.2	4.6	5	5.5	6
	ceiling mounted	/	1.1	1.3	1.4	1.6	1.8	2.1	2.3	2.6	2.8	3.1	3.4	3.7	4

## Maintenance notes

- Check whether the maintenance area or the room area meet the requirement of “table a”- the unit is only allowed to be operated in rooms that meet these requirements.
- Check whether the maintenance area is well-ventilated. - The continuous ventilation status should be kept during the entire operation process.
- Check whether there is a fire source or potential fire source in the maintenance area. Running fire is prohibited in the maintenance area and the “no smoking” sign should be hanged.
- Check whether the warning sign is in good condition, otherwise replace it.

## Welding

- If it is necessary to cut or weld the refrigerant system pipes in the maintenance procedures, please follow the steps here below:
  - a. Shut down the unit and cut power supply
  - b. Eliminate the refrigerant
  - c. Vacuum with a vacuum machine
  - d. Clean the pipes with the N2 gas
  - e. Cut and weld or
  - f. Bring the unit to a service centre for welding
- The refrigerant should be recycled in a specialized storage tank.
- Make sure there aren't any free flames near the outlet of the vacuum pump and that it's well-ventilated.

## Filling the refrigerator circuit

- Use refrigerant filling appliances specialized for R32. Make sure that different kinds of refrigerant don't contaminate one another.
- The refrigerant tank should be kept upright when filling with the refrigerant.
- Stick the label on the system after filling is finished.
- Don't overfill.
- After filling is finished, please test the unit for leakage detection before the operation test; another test for leakage detection should be carried out when the refrigerant is removed.

## Safety instructions for transportation and storage

- Please use a flammable gas detector to check before unloading and opening the container.
- No fire source and no-smoking.
- According to the local rules and laws

# TESTING AND OPERATION

## Functional testing

Connect the power and press the ON/OFF button on the remote control to start operation. Press the MODE button to select AUTO, COOL, DRY, FAN and HEAT mode and check the air conditioner operates normally.

If the ambient temperature is below 16°C, the air conditioner will be unable to start cooling.

## APPENDICES

### Piping configuration

Connecting pipe diameter		Additional refrigerant
Liquid pipe (mm)	Gas pipe (mm)	(g/m)
Φ6.35	Φ9.52	20

### Procedure for extending the piping

#### N.B.:

Improper extension of piping is the main cause of refrigerant leaks. Proceed as shown below:

#### 1. Cut the pipe

- Check the length of the pipe based on the distance between the indoor unit and outdoor unit.
- Cut the required pipe using a pipe cutter.

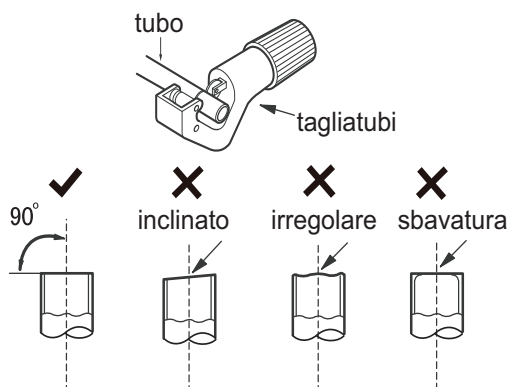

tubo	pipe
tagliatubi	pipe cutter
inclinato	slanted
irregolare	uneven
sbavatura	burred

#### 2. Remove burrs

- Remove burrs with a file, ensuring they do not go into the pipe.

#### 5. Expand the port

Expand the port using a pipe expander.

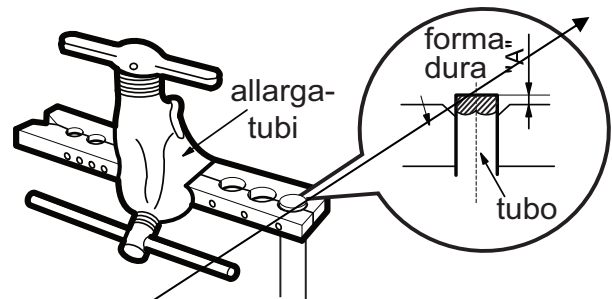

allargatubi	pipe expander
forma dura	hard mould
tubo	pipe

#### N.B.:

- "A" varies according to diameter:

Outdoor diameter (mm)	A (mm)	
	Max.	Min.
6.35 (1/4")	1.3	0.7
9.52 (3/8")	1.6	1.0



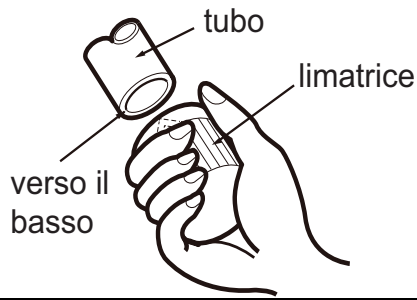

tubo	pipe
limatrice	file
verso il basso	downwards

### 3. Secure an insulating tube

### 4. Install a union nut

- Remove the union nut on the indoor connecting pipe and outdoor valve. Install the union nut on the pipe.



tubo di raccordo	union pipe
tubo	pipe

### 6. Inspection

Check the quality of the expanded port. If defective, expand the port again following the procedure described above.

superficie liscia

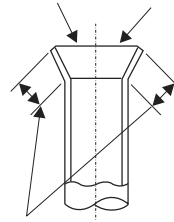

allargamento imperfetto

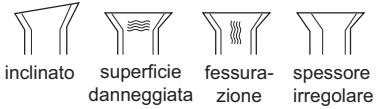

lunghezza uguale

superficie liscia	smooth surface
allargamento imperfetto	defective expansion
lunghezza uguale	equal length
inclinato	slanted
superficie danneggiata	surface damaged
fessurazione	cracked
spessore irregolare	uneven thickness

**REGULATION (EU) No. 517/2014 - F-GAS**

The unit contains R32, a fluorinated greenhouse gas with global warming potential (GWP) = 675.

Do not release R32 into the atmosphere.

**X3MI ECO 52SHB - Kg. 1,00 = 0,675 Tonn CO<sub>2</sub> equiv.**

**X3MI ECO 61SH - Kg. 1,60 = 1,080 Tonn CO<sub>2</sub> equiv.**

**X3MI ECO 71SH - Kg. 1,80 = 1,215 Tonn CO<sub>2</sub> equiv.**

**X3MI ECO 80SH - Kg. 2,00 = 1,350 Tonn CO<sub>2</sub> equiv.**

**X3MI ECO 105SH - Kg. 2,75 = 1,856 Tonn CO<sub>2</sub> equiv.**

**X3MI ECO 120SH - Kg. 2,75 = 1,856 Tonn CO<sub>2</sub> equiv.**



improve your life

[www.argoclima.com](http://www.argoclima.com)