



improve your life

# ECOLIGHT PLUS SINGLE SPLIT AIR CONDITIONERS – R32

## USER and INSTALLATION MANUAL



### INDOOR UNIT

ECOLIGHT PLUS 9000 UI

ECOLIGHT PLUS 12000 UI

ECOLIGHT PLUS 18000 UI

ECOLIGHT PLUS 24000 UI

### OUTDOOR UNIT

ECOLIGHT PLUS 9000 UE

ECOLIGHT PLUS 12000 UE

ECOLIGHT PLUS 18000 UE

ECOLIGHT PLUS 24000 UE

**Please read this manual carefully before installing and using the air conditioner, and retain for future reference.**

# Contents

<b>Information for use</b>	
The Refrigerant	58
Precautions for use	59
Description of components	61
<b>Guide to the remote control and display</b>	
Remote control buttons	62
Getting to know the display icons	62
Getting to know the remote control buttons	63
Getting to know the button combination functions	66
Replacing the remote control batteries	67
WiFi Guide (Optional)	68
Google Home Instruction	78
Emergency operation	86
<b>Maintenance</b>	
Care and cleaning	86
<b>Troubleshooting</b>	
Possible faults and solutions	87
Analysing faults and solutions	89
<b>Installation instructions</b>	
Installation warnings	90
Choosing a location for installation	91
Electrical connection requirements	92
<b>Installation</b>	
Indoor unit installation	92
Outdoor unit installation	96
Post-installation checks	100
<b>Testing and operation</b>	
Functional testing	100
<b>Appendices</b>	
Piping configuration	101
Safety operation of flammable refrigerant	103
Procedure for extending the piping	104
Warnings for the refrigeration system specialist	

## **INFORMATION FOR CORRECT DISPOSAL OF THE PRODUCT IN ACCORDANCE WITH THE EUROPEAN DIRECTIVE 2012/19/EU**



At the end of its working life this equipment must not be disposed of as an household waste. It must be taken to special local community waste collection centres or to a dealer providing this service. Disposing of electrical and electronic equipment separately avoids possible negative effects on the environment and human health deriving from an inappropriate disposal and enables its components to be recovered and recycled to obtain significant savings in energy and resources. In order to underline the duty to dispose of this equipment separately, the product is marked with a crossed-out dustbin.



Appliance filled with flammable gas R32.



Before using the appliance, read the owner's manual.



Before installing the appliance, read the installation manual.



Before repairing the appliance, read the service manual.

## The Refrigerant

- To realize the function of the air conditioner unit, a special refrigerant circulates in the system. The refrigerant is the fluoride R32 = GWP (Global warming potential). This refrigerant is flammable and inodorous. It can lead to explosions under certain conditions, however the flammability of this refrigerant is very low and it can be ignited only by fire.
- Compared to other common refrigerants, R32 is a non-polluting refrigerant with no harm to the ozonosphere and a lower effect upon the greenhouse effect. R32 has very good thermodynamic features which lead to a really high energy efficiency. The units therefore need less filling.

## Warning:

Do not try to accelerate the defrosting process or to clean the appliance in different ways other than those recommended by the manufacturer. Should repair be necessary, contact your nearest authorized Argoclima Service Centre. Any repairs carried out by unqualified personnel may be dangerous. The appliance has to be stored in a room that doesn't have any continuously operating ignition sources. (for example: open flames, an operating gas appliance or an operating electric heater.) Do not pierce or burn.

Appliance has to be installed, operated and stored in a room with a floor area larger than X m<sup>2</sup>. (Please refer to table "a" in section of " Safety Operation of Inflammable Refrigerant" for Space X.) For repairs, strictly follow manufacturer's instructions only for appliances filled with R32 flammable gas. Be aware that refrigerants do not have any odour.

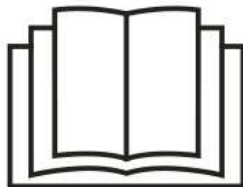

## INFORMATION FOR USE









### Precautions for use

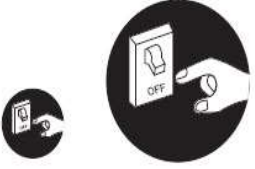

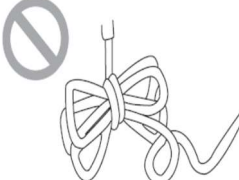
#### WARNING

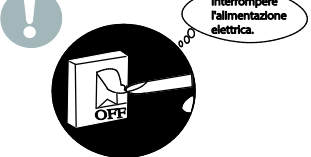
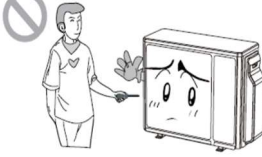
- This product is not a toy. Children of less than 3 years should be kept away unless continuously supervised.
- This device is not intended for persons (including children aged from 8 years and above) with reduced physical, sensory or mental capabilities, or without the necessary experience and knowledge, unless they have received the necessary supervision or instruction concerning use of the appliance by a person responsible for their safety.
- Children aged from 3 and less than 8 years shall only switch on/off the appliance provided that it has been placed or installed in its intended normal operating position and they have been given instruction concerning use of the appliance in a safe way and understand the hazards involved. Children aged from 3 years and less than 8 years shall not plug in, regulate and clean the appliance or perform user maintenance.
- To prevent the risk of fire, do not connect the air conditioner to a multifunction socket.
- Always disconnect the power before servicing or cleaning the unit.
- To prevent the risk of electric shock or malfunction, do not spray water on the indoor unit.
- Do not spill water on the remote control.
- To prevent the risk of electrical shock or damage, do not attempt to repair the air conditioner yourself. After performing the checks in the troubleshooting section, contact an authorised service centre.
- Do not obstruct the inlet or outlet. Otherwise, a fault may occur.
- Contact a qualified technician if it is necessary to move the air conditioner to another location.
- Do not climb on or place heavy objects on the top panel of the outdoor unit. Otherwise, there is a risk of damage or personal injury.
- Do not put fingers or other objects in the air inlet/outlet grilles. Otherwise, there is a risk of damage or personal injury.
- The air conditioner must be properly earthed. Improper earthing can cause electrical shock.
- Always install a circuit breaker. Otherwise, a fault may occur.

- The unit must be installed and serviced by a qualified technician. Otherwise, there is a risk of damage or personal injury.

WARNING		
<p>★ In case of smoke or burning smell, turn off the power supply and contact the service center.</p>  <p>If the problem persists, the unit could be damaged and cause electrical shock or fire.</p>	<p>★ It is necessary that power supply adopts the special circuit with protection through an air switch and ensure it has sufficient capacity. The unit switches on or off automatically according to user needs: do not turn on or turn off the device frequently otherwise it could suffer harmful effects.</p>	<p>★ Do not cut or damage the power cords and control cables. If the power cable and the cable of the control signal are damaged, they must be replaced by a professional technician.</p> 
<p>★ The power supply must be equipped with a special circuit to prevent fire.</p>  <p>Otherwise, it may result in fire or electric shock.</p>	<p>★ Disconnect the power supply if the air conditioner is not used for a long time</p>  <p>Otherwise, the accumulation of dust can cause overheating.</p>	<p>★ Do not damage the power cord or use an unauthorized cable.</p>  <p>Otherwise, it may cause overheating or fire.</p>
<p>★ When cleaning the unit, stop operation and turn off the power.</p>  <p>Otherwise, may occur electric shock or damage.</p>	<p>★ The voltage rating of this product is 220 - 240V, 50Hz. The compressor vibrates strongly if the voltage is too low, causing damage to the cooling system. The electrical components are easily damaged if the voltage is too high.</p>	<p>★ Do not attempt to repair the air conditioner yourself.</p>  <p>An improper repair can cause fire or electric shock. For this reason, it is advisable to contact a service center for repairs.</p>
<p>★ Check if the installed media is sufficiently stable.</p>  <p>If damaged, it can cause the equipment to fall and cause injury.</p>	<p>★ Do not climb on the outdoor unit or place anything on it.</p>  <p>The falling of the outdoor unit can be dangerous</p>	<p>★ Earthing: The unit must be properly grounded. The cable grounding must be connected with the appropriate device in the building.</p> 

#### REQUIREMENTS FOR INSTALLATION AND MAINTENANCE PERSONNEL

All personnel who carry out installation and / or maintenance operations on the units must be equipped with PEF (European Refrigerators License) as required by the D.P.R. n. 146/2018 implementing Regulation (EU) no. 517/2014. If another technician is required to maintain and repair the equipment, this will need to be supervised by the person who is qualified to use flammable refrigerants.

The repair must be performed according to the methodology indicated by the manufacturer of the equipment.

If you need to install, move or service the air conditioner, please contact your dealer or local service center for the procedure first. The air conditioner must be installed, moved or maintained by authorized personnel. Failure to do so could result in serious damage, personal injury or death.

## Operating limits

Operating range:

Cooling mode: from -15°C to +43°C (outdoor temperature)

Heating mode: from -15°C to +24°C (outdoor temperature)

## Description of components

### Indoor unit

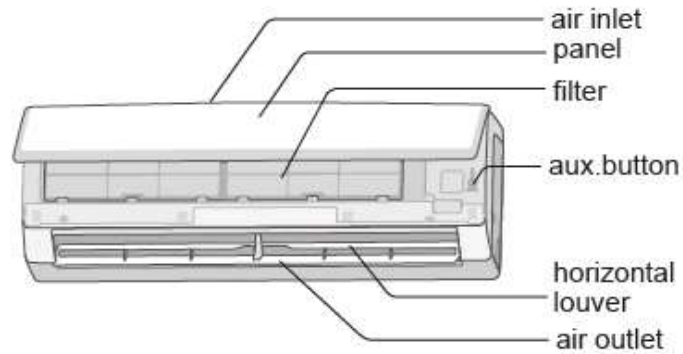

The display may vary from the graphic above. Please refer to the purchased product for the actual display content and positions).

### Outdoor unit

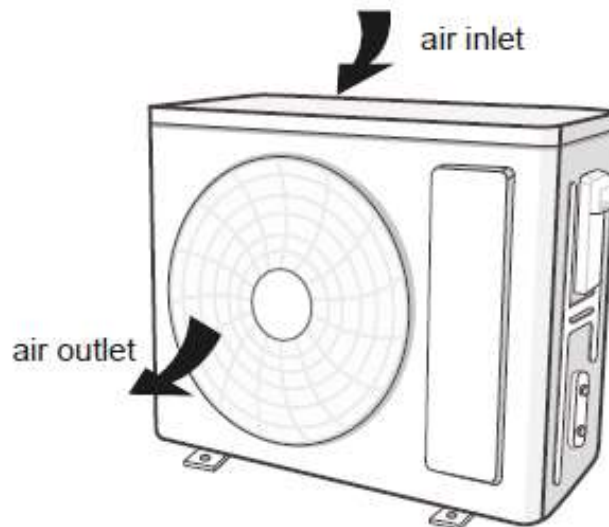

# GUIDE TO THE REMOTE CONTROL AND DISPLAY

## Remote control buttons

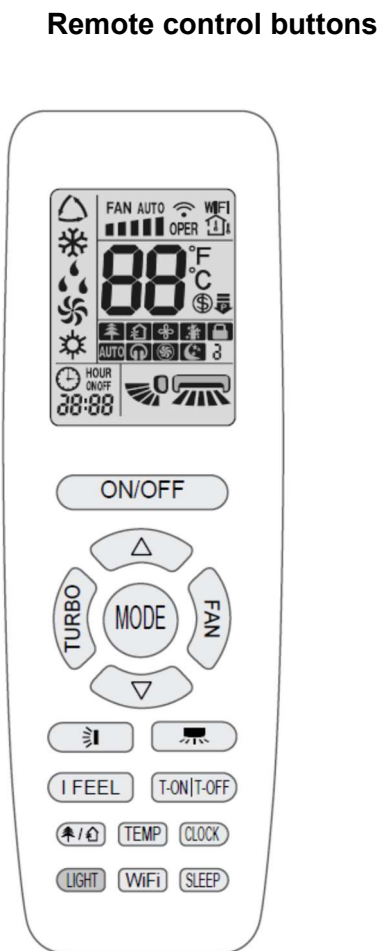

## Icons on display

	Set fan speed
	Send signal
	WiFi function
	Set temp.
	Indoor ambient temp.
	Outdoor ambient temp.
	Auto mode
	Cool mode
	Dry mode
	Fan mode
	Heat mode
	Set temperature
	8°C heating function
	Health mode
	Scavenging function
	X-FAN function
I feel	
	Child lock
	Quiet
	Turbo mode
	Sleep mode
	Clock
	TIMER ON / TIMER OFF
	Set time
	Up & down swing
	Left & right swing
	Power limiting operation



## Introduction to icons on the display

N.	Button	Function
1	ON/OFF	Turns the unit on or off
2	TURBO	Set the turbo function
3	MODE	Set the operating mode
4		Set the up & down swing mode
5	I FEEL	Set the I FEEL function
6	TEMP	Switches the type of temperature display on the unit display
7		Set the Health function and the Scavenging function (not available)
8	LIGHT	Set the Light function
9	WIFI	Set the WIFI function (Optional)
10	SLEEP	Set the Sleep function
11	CLOCK	Set the clock
12	TOFF	Set the Timer off function
13	TON	Set the On Timer function
14		Set swing left & right (not available)
15	FAN	Set the fan speed
16		Set temperature and time

# Introduction to the remote control buttons

## Preliminary operations

When using the infrared remote control for the first time or after replacing the batteries, set the system time to the current time by following the steps below.

- (1) By pressing the CLOCK button, the icon  flashes.
- (2) By pressing  or , the clock time increases or decreases rapidly.
- (3) Press the CLOCK button again to confirm the time and return to the current time display.

## Introduction to operation

### ON/OFF BUTTON

Press this button to select your required operation mode.

After connecting the power supply, the indoor unit will emit a beep, the icon  will light up.

With the unit on, by pressing the ON / OFF button on the remote control, the icon  will flash on the remote control display, and the indoor unit will emit a sound to indicate that the signal has been sent from the remote control. You can then use the remote control to set the various functions.



For models with built-in WiFi or wired controlled, the indoor unit must have been controlled by a standard remote controller in automatic mode before, so that the temperature regulation function in automatic mode can be used via APP or remote control. wire.

### MODE BUTTON

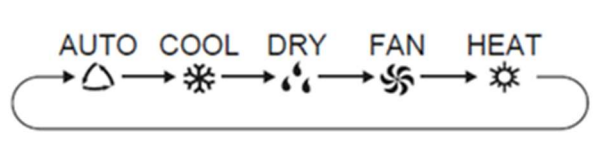
Operation mode selection. With the unit on, press the MODE button to select the operating mode in the following sequence: AUTO -> COOL (cooling) -> DRY (dehumidification) -> FAN (ventilation) -> HEAT (heating)





By selecting the Auto mode, the air conditioner operates according to the factory settings. Press the FAN button to adjust the fan speed. Press the flap swing keys to adjust the swing angle.

By selecting the Cool mode, the air conditioner works in Cooling mode: press the buttons   to set the temperature. Press the FAN button to adjust the fan speed. Press the flap swing keys to adjust the swing angle.

By selecting the Dry mode, the air conditioner operates in Dehumidification, at low fan speed: the temperature cannot be adjusted.

Press the flap swing keys to adjust the swing angle.

By selecting the FAN mode, the air conditioner operates in Ventilation only: Press the FAN button to adjust the ventilation speed. Press the flap swing keys to adjust the swing angle.

By selecting HEAT mode, the air conditioner operates in Heating mode: press the buttons   to set the temperature. Press the FAN button to adjust the fan speed. Press the flap swing keys to adjust the swing angle.

### NOTE:

To prevent the introduction of cold air into the environment, after the start of Heating mode the indoor unit will take 1 ~ 5 minutes to admit air (the actual delay time depends on the internal ambient temperature).

Set the temperature range by remote control: 16 ~ 30 °C (61-86 ° F);



In automatic mode, the temperature can be displayed;

In automatic mode, it is also possible to adjust the set temperature. This mode indicator is not available for some models.



## BUTTONS

Temperature setting

With the unit switched on, press the button  to increase the set temperature by 1 ° C and the button  to decrease it. The temperature adjustment range is between 16 and 30 ° C.

To set the desired temperature more quickly, hold down the two buttons simultaneously for 2 seconds.

## FAN BUTTON

Adjustment of the ventilation speed

With the unit turned on, press the FAN button to adjust the fan speed in the following sequence: Auto, Low, Medium, High.

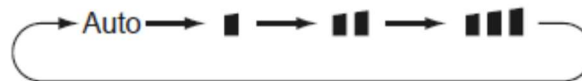

Note:

In AUTO mode, the ventilation will work with the factory settings.

If the operating mode is changed, the fan speed is memorized;

In Dry mode, the fan speed is low and cannot be adjusted.

## X-FAN function

By holding down the FAN button for 2 seconds in Cool (cooling) or DRY (dehumidification) mode, the icon  will appear and the internal fan will continue to operate for a few minutes in low ventilation speed, even when the unit is turned off. This is to allow the evaporator of the indoor unit to dry, thus avoiding the formation of mold. When the unit is switched on, the X-fan function is not set by default.

This function is not available in AUTO, fan and heat modes.

If you want to stop the X-fan function, press and hold the FAN button again for 2 seconds.

## Turbo function setting

In Cool or Heat mode, press the TURBO button to set the Turbo function.

When is displayed , it means that the Turbo function is activated.

When it is not displayed , it means that the Turbo function is turned off.

When the Turbo function is on, the unit runs at full speed to quickly achieve cooling or heating. When the Turbo function is deactivated, the unit operates at the set fan speed.

## Right / left swing setting



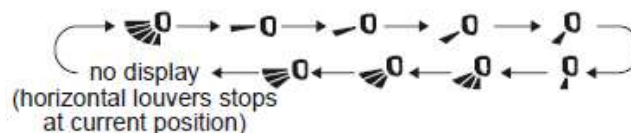

Function not available.

## Up / down swing setting

Press the key  to circularly adjust the swing angle up / down in this sequence:



When selected , the flap automatically swings at the maximum angle up and down.

When one of these symbols is selected     , the flap remains fixed in that position.

These positions    correspond to a fixed angle oscillation.

They may not be available: in this case the flap will swing automatically.

Hold the button down for 2 seconds to fix the flap in the desired position: when the flap reaches the desired position, release.

In high / low swing mode, when the state is switched from off to, if you press this key again  for 2 seconds, the state goes directly to the off state; if this key is pressed again within 2 seconds, the change of oscillation state will also depend on the circulation sequence indicated above

## Setting the Light function

The light on the light panel receiver displays the current operating status. If you want to turn off the light, press the LIGHT button. Press this button again to turn on the light. The corresponding icon will be 

## Room temperature display

By pressing this button, you can see indoor set temperature, indoor ambient temperature or outdoor ambient temperature on indoor unit's display. The setting on remote controller is selected circularly as below:

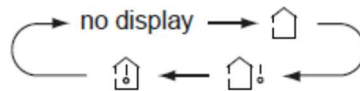

When selecting " " or no display with the remote controller, the temperature indicator on the indoor unit displays the set temperature.

When selecting " " with the remote controller, the temperature indicator on the indoor unit displays the indoor ambient temperature.

When selecting " " with the remote controller, the temperature indicator on the indoor unit displays the outdoor ambient temperature.

The outside temperature display is not available for some models. At that time, the indoor unit receives the " " signal while displaying the set indoor temperature.

It is default to display the set temperature when the unit is turned on. There is no display in the remote control.

Only for models whose indoor unit is equipped with dual-8 display.

When indoor or outdoor room temperature display is selected, the indoor temperature indicator displays the corresponding temperature and automatically turns to display the set temperature after three to five seconds.

## Setting the Wifi function (optional)



Press this button to activate or deactivate the Wifi function (see chapter Wifi).

## Setting Health and Scavenging functions

Functions not available.

## Setting the Sleep function

In COOL or HEAT mode, press this button to start the Sleep function.

The " " icon is displayed on the remote control. Press this button again to cancel the Sleep function and the " " icon will disappear.

After power on, the default setting is disabled. After the unit is turned off, the Sleep function is canceled.

In this mode, the set temperature will be adjusted with the time change. In Fan, DRY and Auto modes, this function is not available

## Setting I FEEL function

Press the I FEEL button to activate or deactivate the I FEEL function.

When the icon  is displayed, it means that the I FEEL function has been activated.

Once this function is set, the remote control will send the detected room temperature to the indoor unit at regular intervals, which will automatically adjust its operation in order to reach the set temperature.

Press this button again to cancel the I FEEL function and the icon will disappear.

Place the remote control close to the user when this function is set: Do not place the remote control near high or low temperature objects to avoid detecting an inaccurate room temperature. When the I FEEL function is activated, the remote control must be placed within a confined indoor area, where the unit can receive the signal sent by the remote control.

## Setting the timer

You can set the operating time of the unit as needed. You can also set Timer on and Timer off in combination.

Before setting, check if the time set on the remote control is correct. If not, adjust the time.

### (1) Setting the Timer off function

- By pressing the TOFF button, "OFF" flashes and the time indication shows the last set time of the timer.
- Press the  $\Delta$  or  $\nabla$  button to set the timer hour.
- Press the TOFF button again to confirm the setting. OFF is displayed and the time indication continues to show the current time.
- Press the TOFF button once again to cancel the timer; OFF is not displayed.

### (2) Setting the On Timer function

- By pressing the TON button, "ON" flashes and the time indication shows the last set time of the timer.
- Press the  $\Delta$  or  $\nabla$  button to set the timer hour.
- Press the TON button again to confirm the setting. ON is displayed and the time indication continues to show the current time.

## Introduction to the functions of key combinations

### Child lock setting

Press  $\Delta$  and  $\nabla$  simultaneously to lock the buttons on the wireless remote control until the icon  is displayed.

Press  $\Delta$  and  $\nabla$  simultaneously again to unlock the buttons on the wireless remote control until the icon disappears.

When the keys are locked, if a key is pressed and its function is invalid, the icon  blinks 3 times.

### Changeover of temperature unit of measurement between °C and °F

With the unit off, press the MODE and  $\nabla$  keys simultaneously to switch the temperature scale between °C and °F.

### Energy saving function setting

With the unit turned on and in cooling mode, press the TEMP and CLOCK button simultaneously to enter the power saving mode.

The display of  indicates that the power saving function is activated.

Failure to display  indicates that the power saving function is disabled.

If you want to deactivate the power saving function, press the TEMP and CLOCK buttons and  is not displayed.

In this mode the fan speed is fixed, in Automatic mode and cannot be adjusted.

The temperature cannot be set. If you press the TURBO button, the signal is not sent from the remote control.

The Sleep and Energy Saving functions cannot operate at the same time: if the Energy Saving function has been set, pressing the Sleep button will deactivate it. If you have selected the Sleep function, by activating the Energy Saver function, the Sleep function is deactivated.

### 8°C heating function

In heating mode, press the "TEMP" and "CLOCK" buttons simultaneously to start or disable the 8 °C heating function.

When this function is started, " " and "8 °C" will be displayed on the remote controller and the air conditioner will keep the heating status at 8°C. Simultaneously press the "TEMP" and "CLOCK" buttons again to exit the 8°C heating function.

With the 8 °C heating function, the fan speed defaults to automatic speed and cannot be adjusted.

With the 8 °C heating function, the set temperature cannot be adjusted. Press the "TURBO" button and the remote control will not send signal.

The sleep function and the 8 °C heating function cannot work at the same time. If the 8 °C heating function has been set in cooling mode, press the "SLEEP" button to cancel the 8 °C heating function. If the sleep function has been set in cooling mode, starting the heating function at 8 °C will cancel the sleep function.

In temperature mode °F, the remote will display 46 °F heating.

### Autoclean function

With the unit off, press and hold the MODE and FAN buttons simultaneously for 5 seconds to activate or deactivate the automatic cleaning function. When the automatic cleaning function is activated, the indoor unit displays "CL".

The function will see condensation, ice formation, defrosting and drying phases take place in sequence aimed at eliminating all residues of dust and pollutants and any trace of condensation from the evaporator. This will always allow clean air to

be introduced into the environment and to preserve the efficiency of the heat exchanger

During the automatic evaporator cleaning process, the unit will perform either rapid cooling or rapid heating. There may be some noise and the air conditioner may blow out cold or hot air. During the cleaning process, make sure the room is well ventilated.

The automatic cleaning function can only work in normal room temperature. If the room is dusty, clean it once a month; otherwise, once every three months. After activating the automatic cleaning function, you can leave the room. At the end of the automatic cleaning, the air conditioner will go back to stand-by.

## Replacing the batteries in the remote control

- (1) Lift the cover in the direction of the arrow (as shown in Fig. 1 ①).
- (2) Take out the original batteries (as shown in Fig. 1 ②).
- (3) Insert two AAA batteries (1.5V), making sure that the position of the "+" and "-" poles is correct (as shown in Fig. 2 ③).
- (4) Reinsert the cover (as shown in Fig. 2 ④).

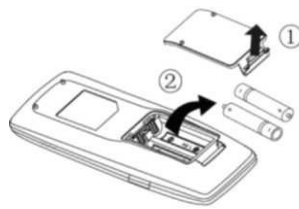

Fig. 1

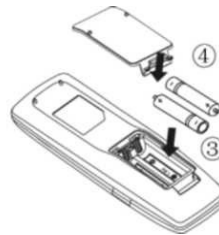

Fig. 2

1. The remote control should be placed within 1m of the TV or stereo system.
2. Remote control operation must be within the reception range.
3. To send commands to the main unit, point the remote control at the unit's signal reception window to improve its reception sensitivity.
4. If the remote control sends the signal, the "📶" icon blinks for 1 second. When the main unit receives the valid remote control signal, it emits a sound.
5. If the wireless remote control does not work normally, take out the batteries and reinsert them after 30 seconds. If it still doesn't work, replace the batteries.
6. When replacing, do not use exhausted batteries and do not mix different types in order to avoid malfunction.
7. If the remote control is not used for a long time, take out the batteries.

### INFORMATION FOR CORRECT DISPOSAL OF BATTERIES IN ACCORDANCE WITH EUROPEAN DIRECTIVE 2006/66 / EC and AMENDMENTS INTRODUCED BY DIRECTIVE 2013/56 / EC



Please replace the battery when its electric charge is exhausted: at the end of its useful life this battery must not be disposed of with unsorted waste. It must be delivered to appropriate separate collection centers or to retailers that provide this service. Disposing of a battery separately allows you to avoid possible negative effects on the environment and human health resulting from inappropriate disposal and allows you to recover and recycle the materials it is made of, with important savings in energy and resources. To emphasize the obligation to dispose of the batteries separately, the symbol of the crossed out bin is shown on the battery. Illegal disposal of the product by the user involves the application of administrative penalties provided for by current legislation.

## WIFI GUIDE (Optional)

It is possible to install the Wifi module to remotely control the air conditioner. The air conditioner must be in constant connection with a wireless router or access point connected to the internet. Mobile devices such as smartphones and tablets, on which dedicated applications are installed and the Wi-Fi modules subsequently configured, can be used as remote controls once connected to the internet.

### How to set up and operate the air conditioner with Wifi

1. Make sure that the device (smartphone or Tablet) used is equipped with a standard version of Android (version 4.4 or higher) and iOS (iOS7.0 or higher) as the operating system. For more details refer to the App.
2. Units can be connected and controlled only via Wi-Fi network or via Hotspot function.
3. Routers with WEP encryption are not supported.
4. The application interface is universal for all products and many features may not match for all units. It may vary depending on the operating system used or the update in use. Refer to the current version.
5. If the access protection on your Router is active in the "MAC Filter" / "MAC address filter" item, enable the access to the network of the MAC address of the device.

### Installation and use instruction

1. Frame the QR Code using a *QR Code Reader*



or search for the "EWPE SMART" application in the app store download and install the application.

Install the App by referring to its guide. Once the installation is complete, the icon  appears on the smartphone's home page.

#### **NB:**

**Before starting any procedure, disconnect the power supply from the product, allow a few minutes to pass and reconnect it.**

### 1. Registration and access.

After installing the application, open "EWPE SMART" and click Sign up to register.

#### **PLEASE NOTE:**

- USERNAME: must be UNIQUE, composed of name + number, without spaces (eg **Rossi57**)
- Personal email: if already registered, retrieve Username / Password. It is not possible to create another account with the same mail.
- PASSWORD: must have at least one capital letter, symbols or special characters (- ;, etc.) and numbers.
- Repeat PASSWORD written above
- EUROPE country

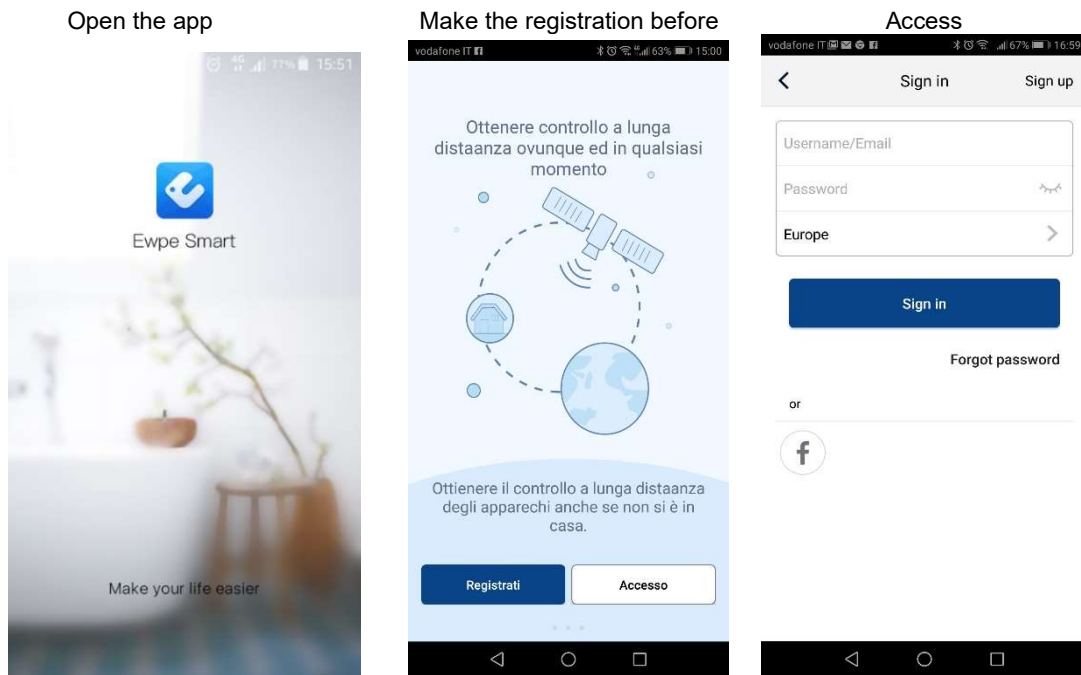

**2. Adding units**

Clicking on the icon of the little man opens a menu that includes, among other things, the "Help" function. Follow the instructions that appear on your device to add the unit. or add a new unit, press + in the upper right corner of the homepage.

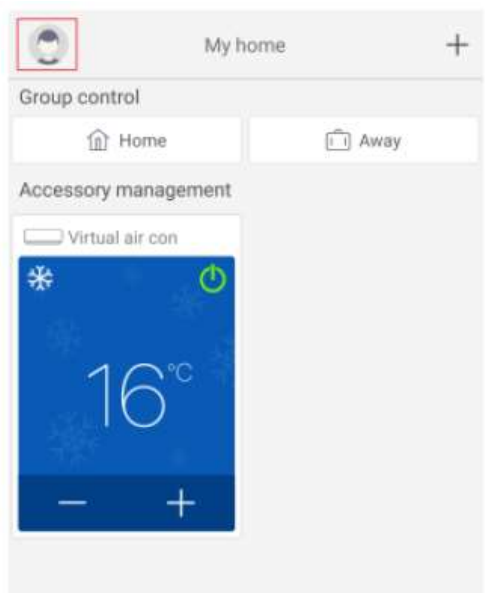

A menu appears with all the categories of devices that can be connected.

Select the relevant type:

In case of **residential air conditioner**: the first box on left

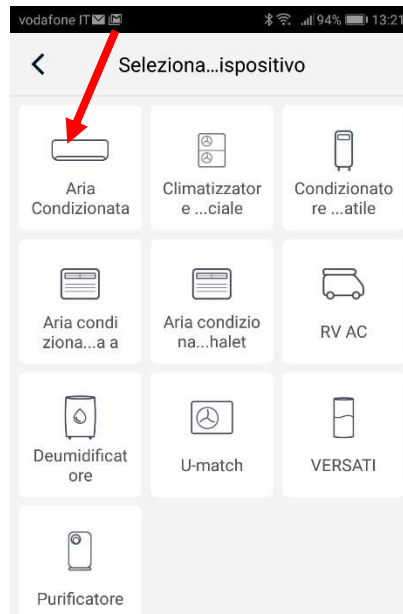

After choosing the category of interest, proceed with the reset of the unit.

Different unit reset systems can be chosen depending on the type of unit / system and remote control (with or without wifi key).

**Follow step by step** the operative instructions depending on the selected reset system.



After performing the reset following the instructions, click on Next to automatically add the unit (it's necessary to enter Wi-Fi password).



<p><b>WIRE CONTROL OR PORTABLE AIR CONDITIONER (CONTROL PANEL RESET)</b></p> <p><b>Press the button on the touch panel.</b></p> <p><b>With the unit off, press and hold the "Wifi" button for 10 seconds. When the unit beeps, it means the reset has been successful.</b></p> <p><b>NB:</b></p> <p><b>The configuration must be done within 2 minutes. If it does not happen within 2 minutes, repeat the reset operation.</b></p>	<p><b>REMOTE CONTROL WITH WIFI BUTTON</b></p> <p><b>Direct the remote control towards the unit.</b></p> <p><b>With the remote control off, press the "Mode" + "Wifi" buttons simultaneously for 1 second. When the unit beeps, it means that the reset has been successful.</b></p> <p><b>NB:</b></p> <p><b>The configuration must be done within 2 minutes. If it does not happen within 2 minutes, repeat the reset operation..</b></p>	<p><b>REMOTE CONTROL WITHOUT WIFI BUTTON (MODE and TURBO)</b></p> <p><b>Direct the remote control towards the unit.</b></p> <p><b>Press the "Mode" + "Turbo" buttons simultaneously for 10 seconds. After the unit has twice produced an acoustic signal, this will mean that the reset has been successful.</b></p> <p><b>NB:</b></p> <p><b>The configuration must be done within 2 minutes. If it does not happen within 2 minutes, repeat the reset operation</b></p>
---	---	--

Alternatively, after setting and resetting the air conditioner, click on *Add appliance manually* in the upper right corner to select the Wi-Fi network to associate.



Select the desired network and continue the configuration.

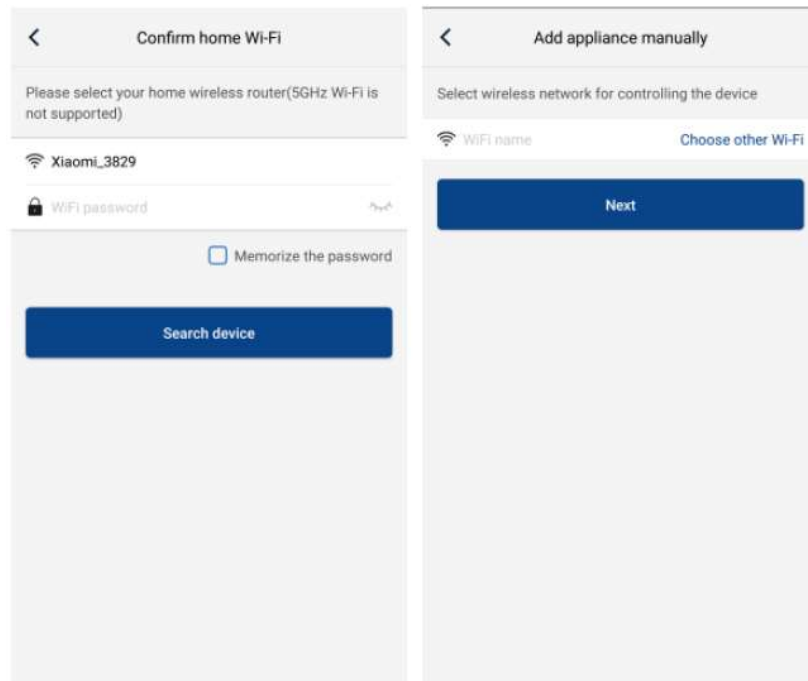

After performing the electrical reset of the unit and entering the information, perform a search for the unit (Search appliance) and continue the configuration.

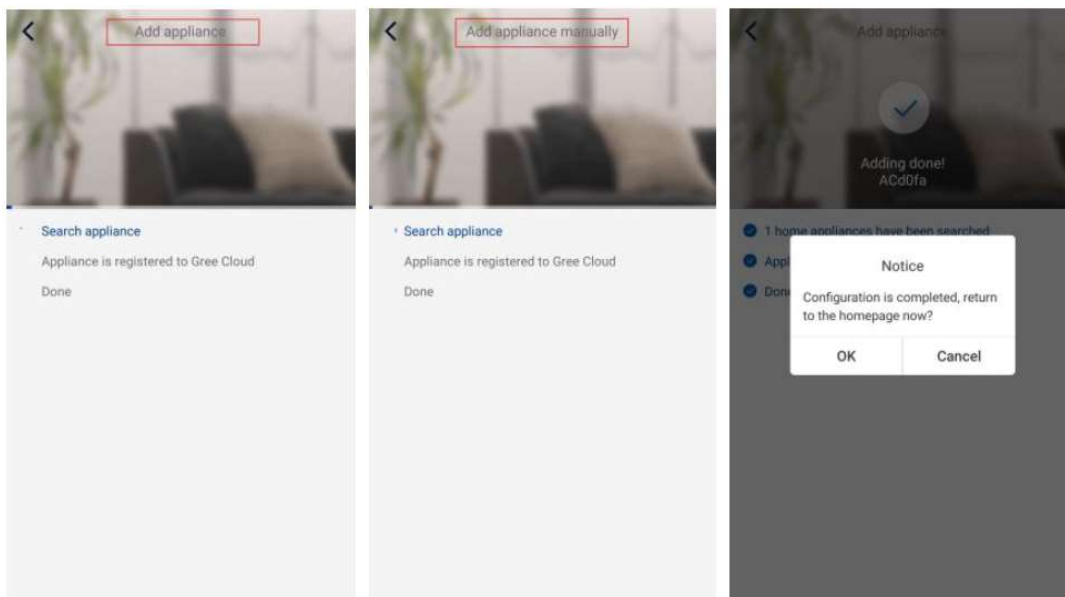

# Configuration of the main functions

In the Homepage click on the device you wish to control and access the operating interface of it.

1. **Select, operating mode, temperature and fan speed.**  
- **Mode**

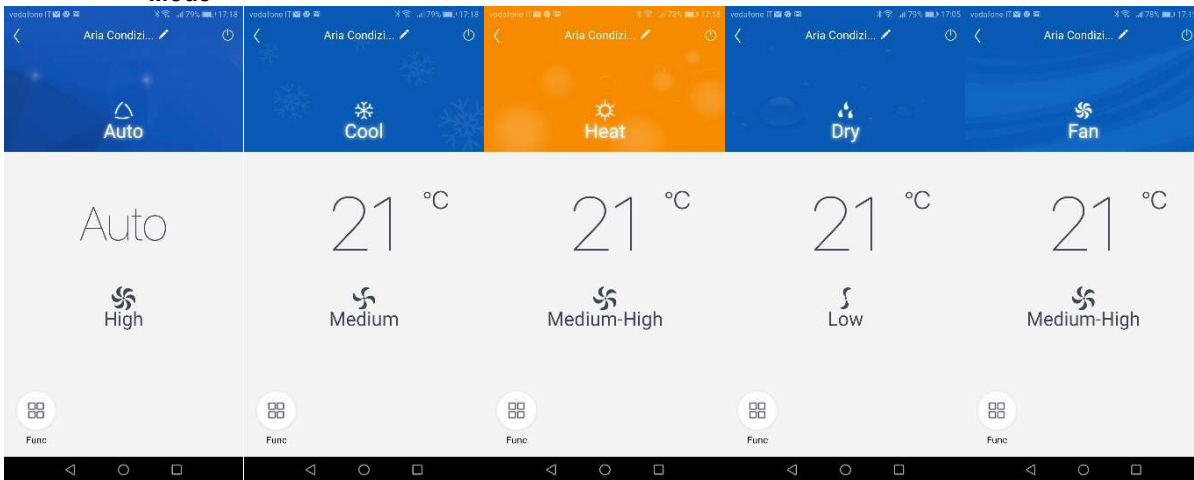

Temperature for each mode: just slide your finger on the indicated temperature

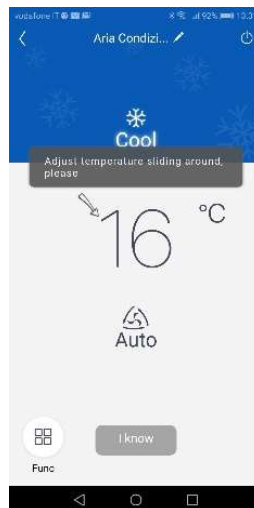

1. **Ventilation speed for each mode: just slide your finger on the fan symbol (the adjustment possibilities vary depending on the mode)**



## 2. Set advanced functions

Click Function (Func) in the lower left corner of the interface to enter the advanced settings.

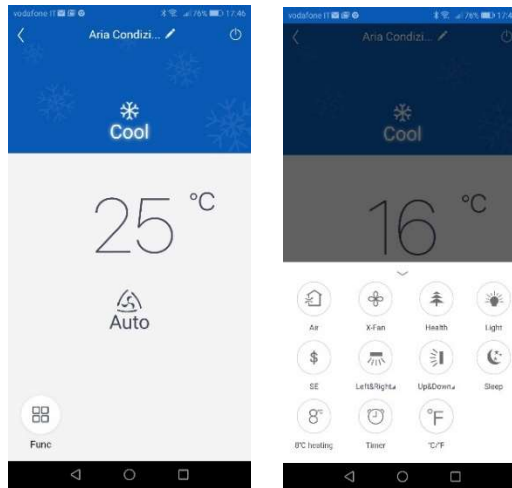

X-FAN function

Vertical flap swinging

Horizontal flap swinging  
(if available)

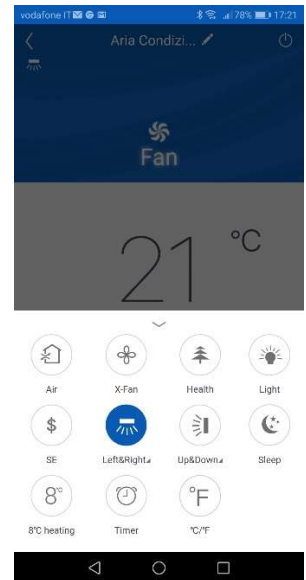
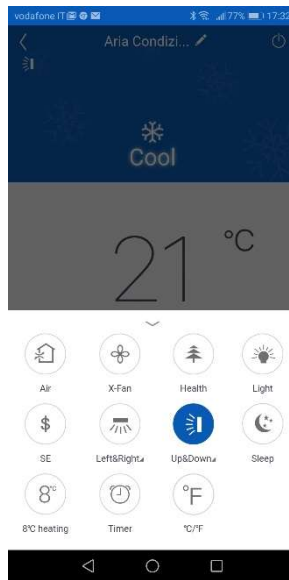
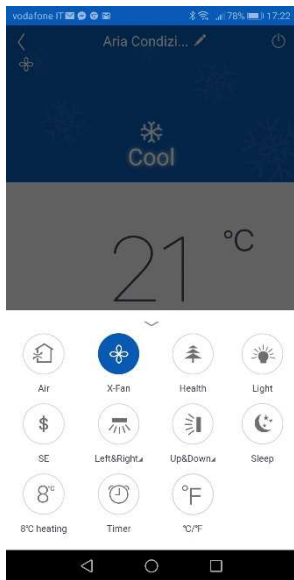

Sleep function

Light on indoor unit display

Temperature unit conversion

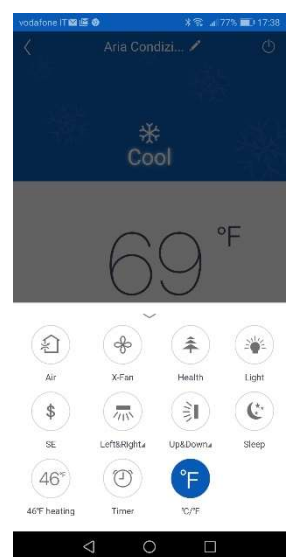
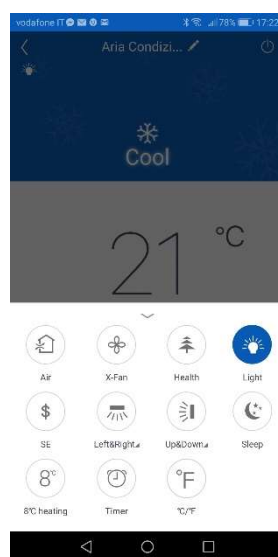

## Swing setting

Click Up & down swing to turn the swing function on or off. Click the arrow in the lower right corner of the icon to go to the next screen and set the swing level.

## List of Preselections

Click Timer. Then click + and make adjustments.

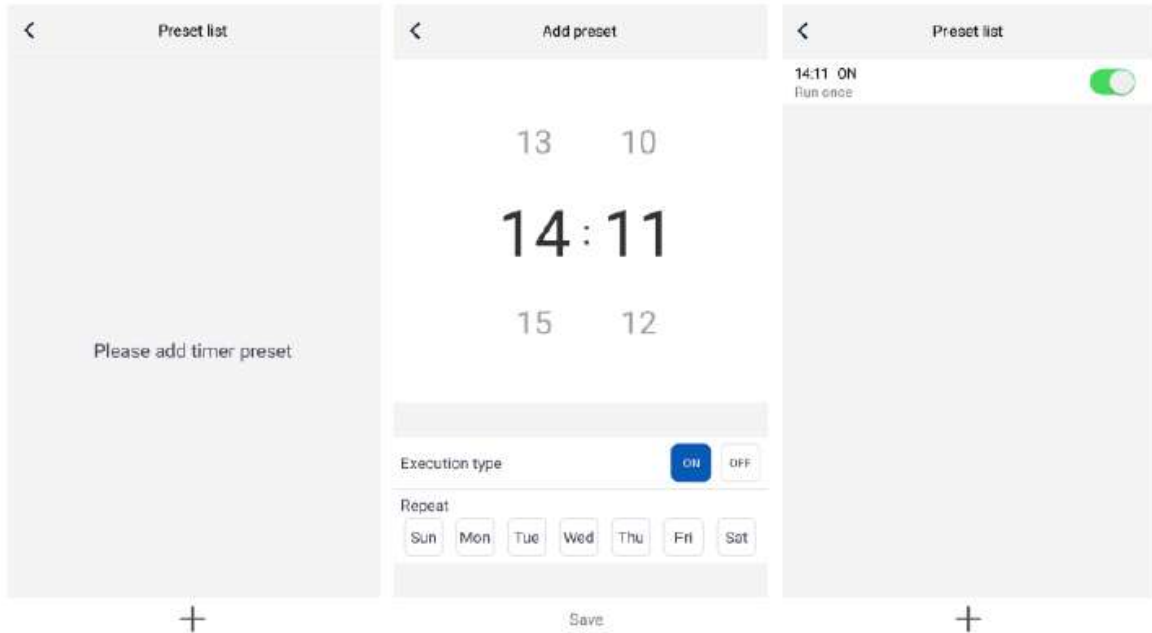

## Other functions

### 1. Homepage menu

Click on the profile picture in  the upper left corner of the homepage and set each menu function.

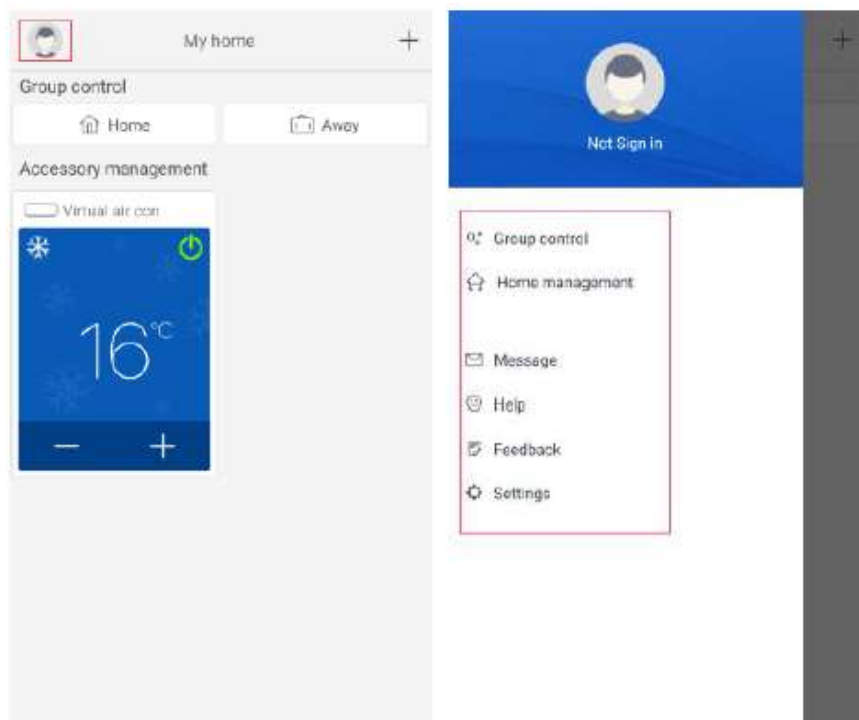

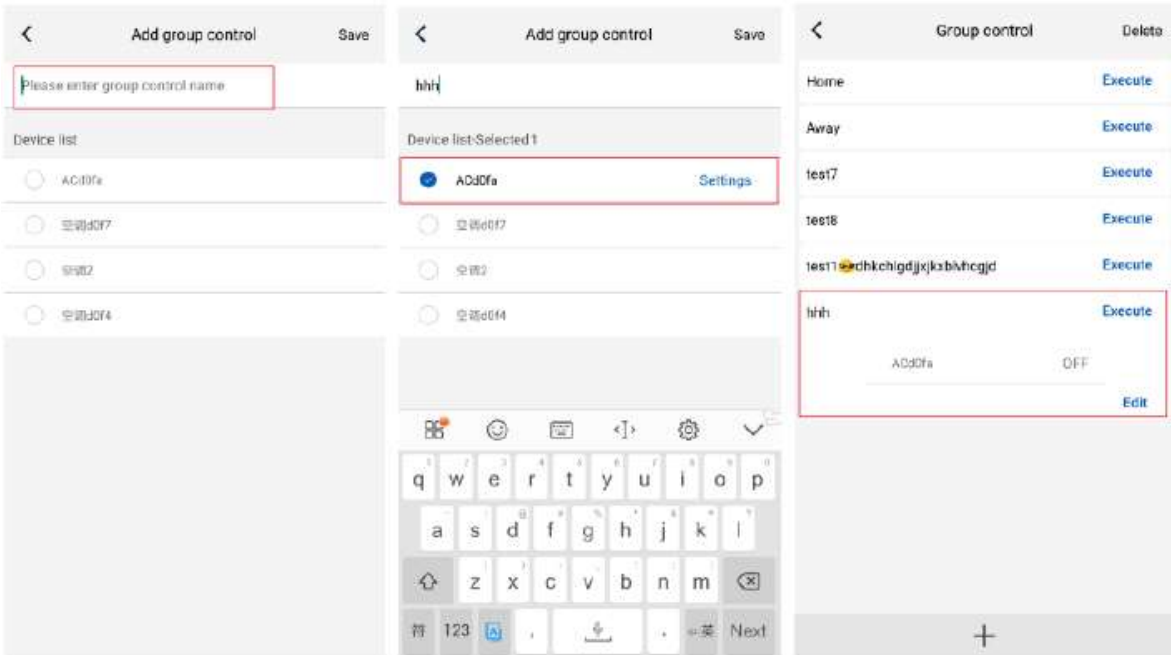

## 2. Group Control

Click Group Control to use the present devices (Ex. Change the group name to "hhh" and set up the devices in the group list). When this group is working you can change the settings of the whole group.

## 3. Home Management

Click Home Management to create or manage a "family system". You can add new members to the family system of the registered account.

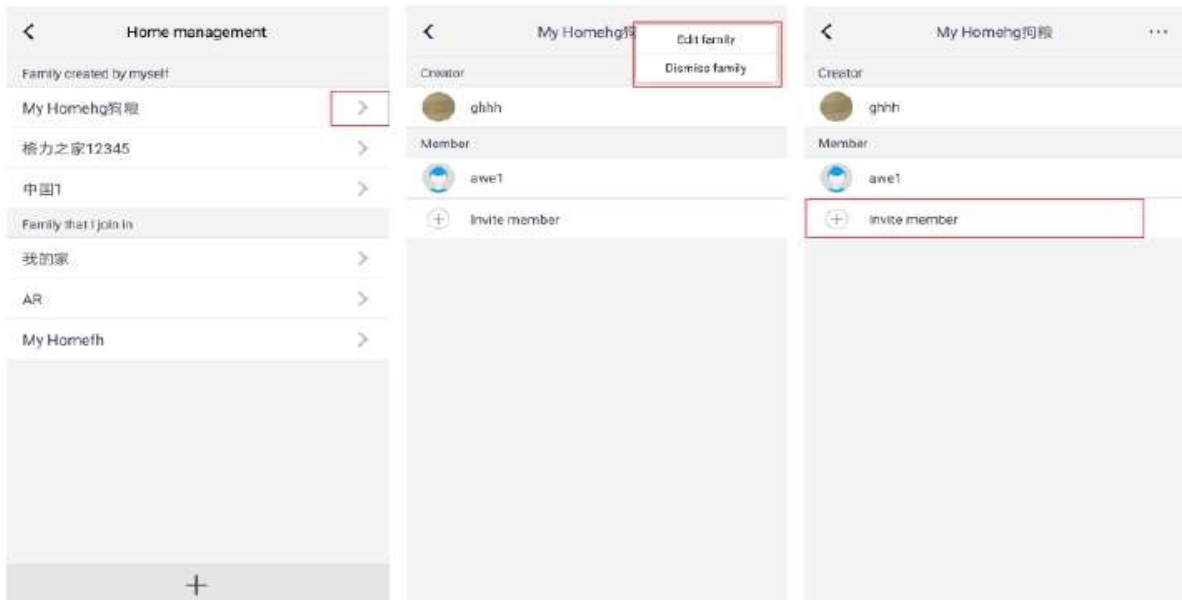

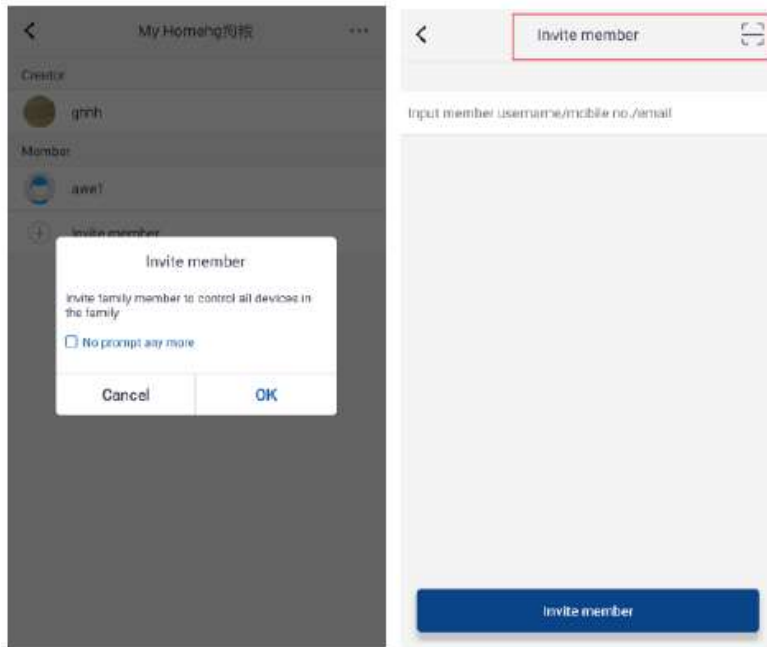

#### 4. Help

Press Help to view the instructions for **EWPE SMART APP**.

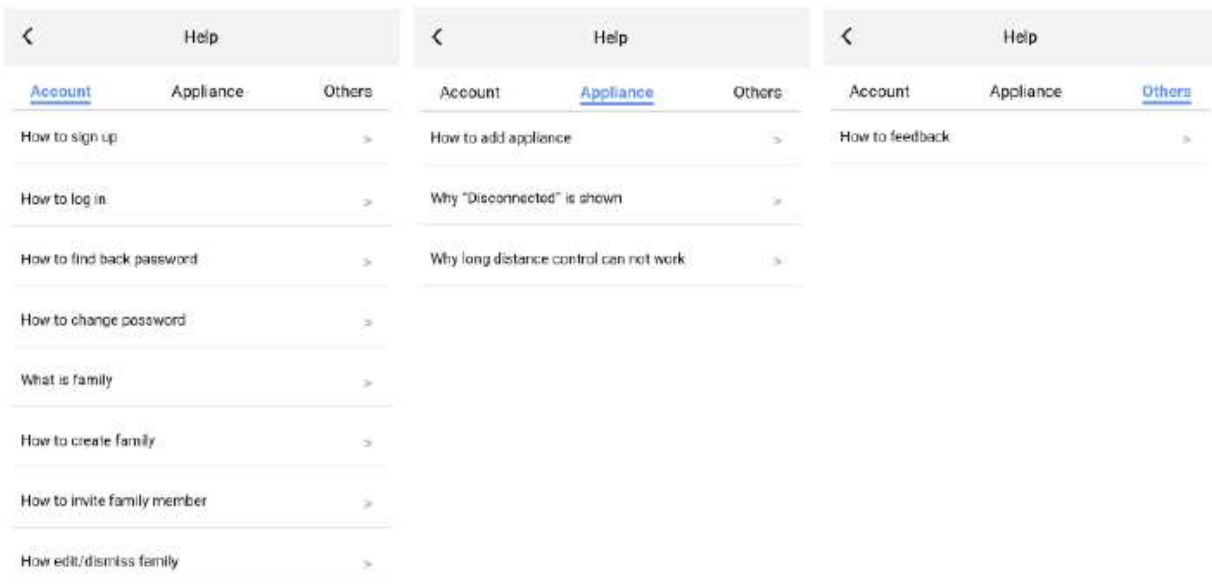

#### 5. Feedback

Click Feedback to send a feedback on the product.

#### 6. How to reset the air conditioner WiFi module:

Turn off the unit with the remote control and disconnect the air conditioner power for at least 10 seconds. Reconnect the power supply. After 1 minute, press the "WiFi" and "Mode" buttons simultaneously. If the air conditioner beeps, it means that the WiFi module has been reset correctly.

Attention: The configuration is carried out within 2 minutes. If it does not happen within 2 minutes, repeat the reset operation.

## Analysis of common network setting errors:

If the short distance control does not work, perform the checks specified below:

- Make sure the air conditioner power is connected.
- Make sure that the air conditioner's WiFi function is normally active.
- Make sure your phone's WiFi selects the corresponding air conditioner.
- Reset with the remote control and restart the setting from step 3.

It is important to remember what is listed below.

1. The WiFi function of the air conditioner takes about 1 minute to start.
2. The air conditioner is equipped with memory function.

# Google Home Instruction

## 1. Premise

Before using Google Home to control intelligent equipment, please make sure you have satisfied the following conditions.

- Your mobile phone has installed the latest version of Google Home app or Google app (for Android only)
- Your mobile phone has installed the latest version of EWPE app.

## 2. Complete device networking configuration according to the guidance of EWPE App

Note: Revise the device name in the App to the one which is easy for Google Assistant to recognize, it is English name generally, e.g: "Proklima Air conditioning".

## 3. Google Home configuration

- If you have configured Google Home, you can skip this step, the following statement is mainly for the Android client.
- Please make sure your Google Home device is energized and connected to Wi-Fi network, the four lights on the cover is on.
- Open Google Home App on the phone, after successful login, "Discover" will appear automatically to wait for the Google device to be connected.
- Click "Setup" to start connecting Google Home device.

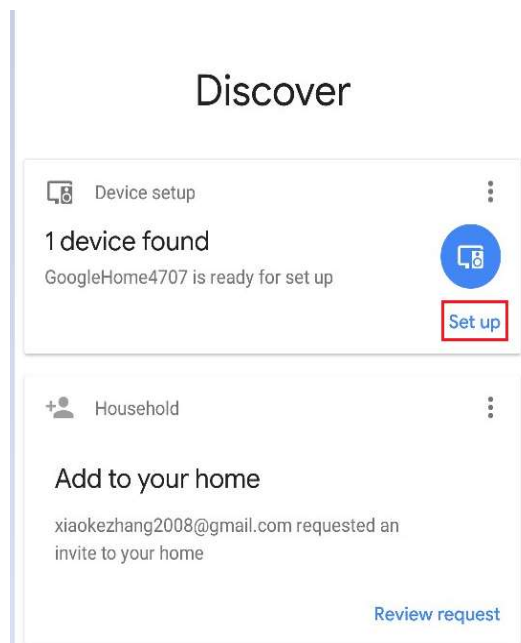

Confirm to add Google Home device and click "Yes".

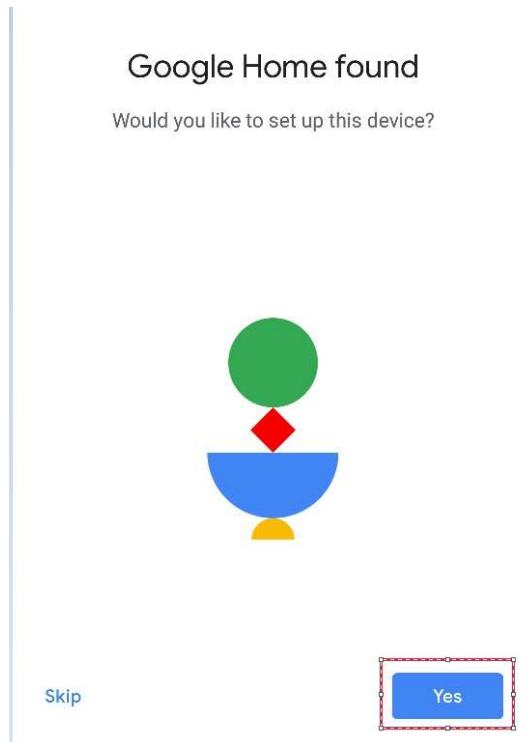

It will give out a sound to confirm that you have connected to the right device. After hearing the sound, click "Yes" to enter the next step.

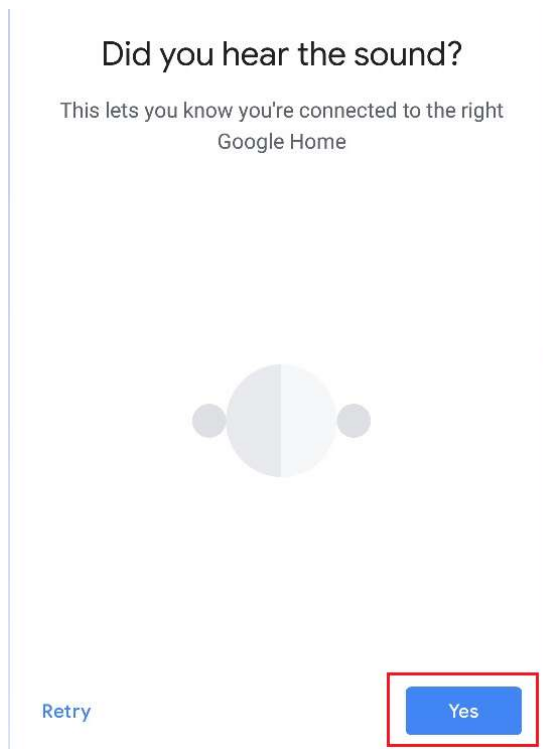

Join in Help Improve Google Home and click "Yes, I'm in" or "No thanks".



### Help improve Google Home

Automatically share device stats and crash reports with Google to improve everyone's experience.

[Learn more](#)



[No thanks](#) [Yes, I'm in](#)

Distinguish the room of Google Home from the other Google device areas, click "NEXT", revise room name and click "Continue".

### Where is this device?

Choose a location for your Google Home. This will help name and organize your devices.

My rooms

- 3783
- Attic

Create new

- Attic**
- Backyard

[Next](#)

### Custom room name

Enter a name for this room. This will be added to your room list

Custom room name

**Attic 2**

[Continue](#)

Then select Wi-Fi network and click "NEXT" to wait for device network connection.

### Connect to Wi-Fi

Choose the Wi-Fi network you would like to use with your Google Home

- Xiaomi\_0A7E
- Xiaomi\_907D
- Xiaomi\_907D\_5G
- voice\_5G
- voice2
- LYKJ-2

[Next](#)

### Before using your Google Assistant

Here are a few things to know before using your Google Home

**Google partners** ▼  
Google partners are businesses that have a commercial relationship with Google.

**Services and your privacy** ▼  
When you use your Assistant to talk to a service, Google shares information with that service so it can fulfill your request.

**Guests and your Assistant** ▼  
Let friends and family know that their interactions will

[Learn more](#) [More](#)

Set Google Home and click “More”.

### Get personal results with your voice

Voice Match has been set up

Now you can turn on personal results to use your voice to access your calendar, contacts, reminders and more on this device.

You can turn off personal results in Assistant settings.

[Learn more](#)



[NO THANKS](#) [I AGREE](#)

Click “I AGREE”.

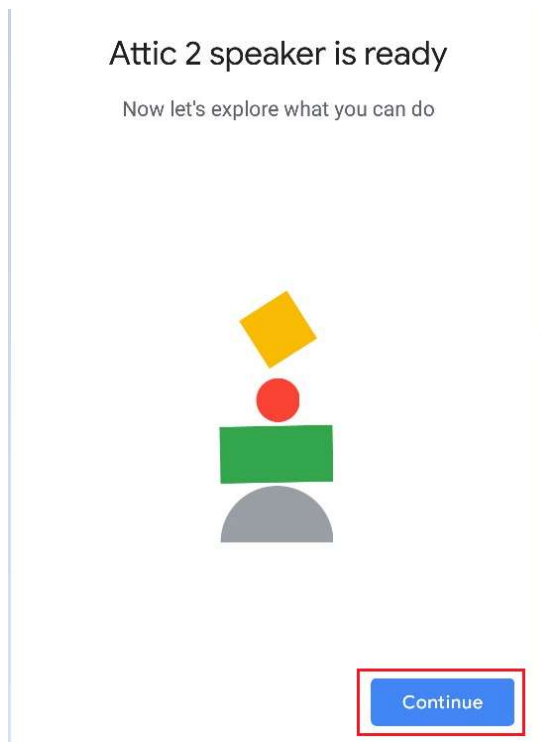

According to the prompting, choose if you agree the corresponding operation, if it displays "Google Home is ready", choose "Continue" to the next step.

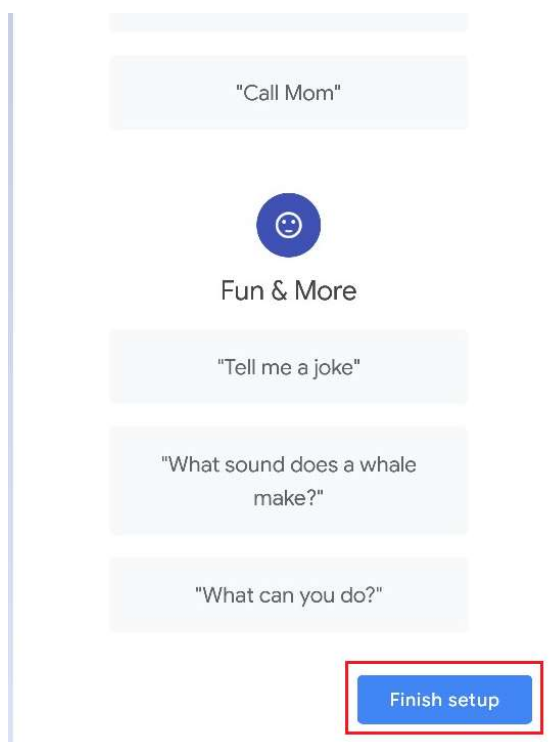

Here comes the language control guidance course, after listening, click "Finish setup", then Google Home setting is completed.

#### 4. Add EWPE app account

- ◆ In Google Home App homepage, click “+” button.

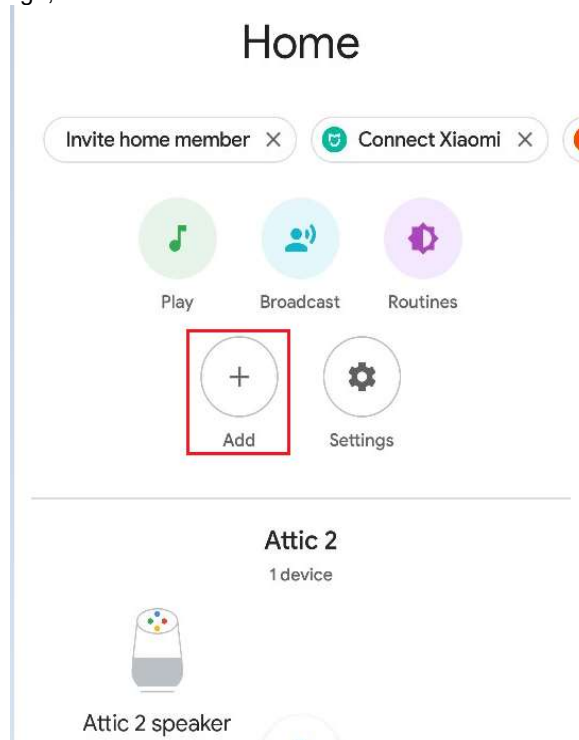

Click “Set up device”.

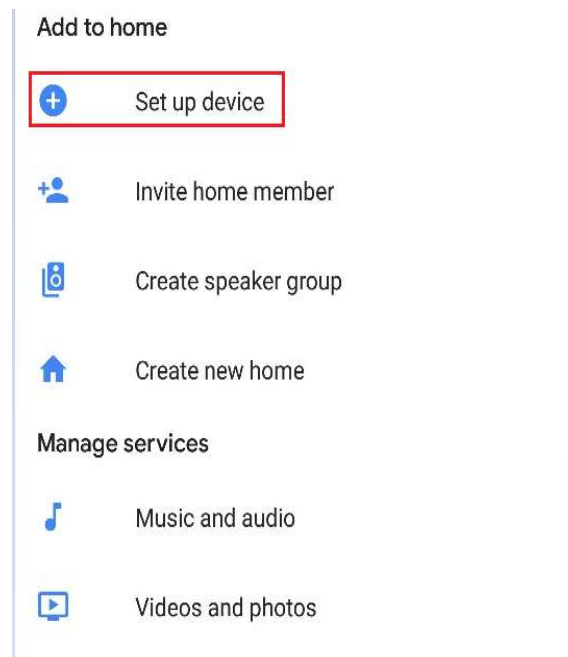

Select Works with Google.

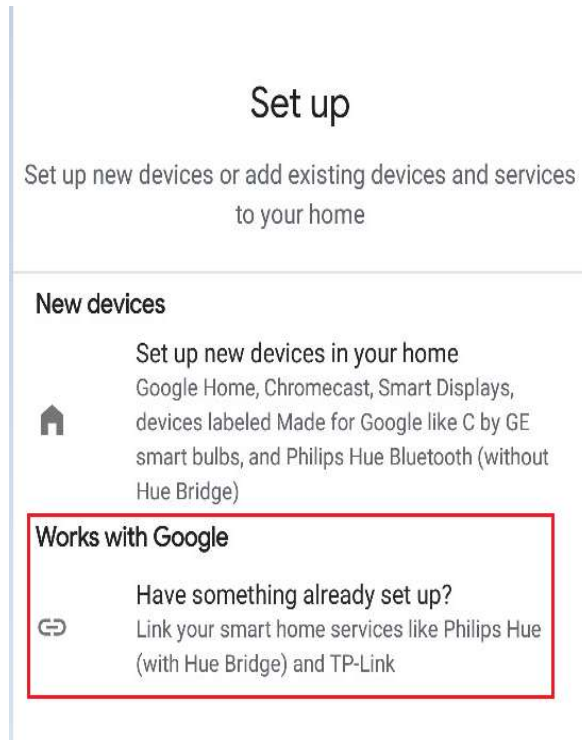

Search "Ewpe SmartHome".

Search Ewpe SmartHome on the list and click it, choose the country where your Ewpe Smart App account is, input EWPE App account and password and click "Ewpe SmartHome" to add it.

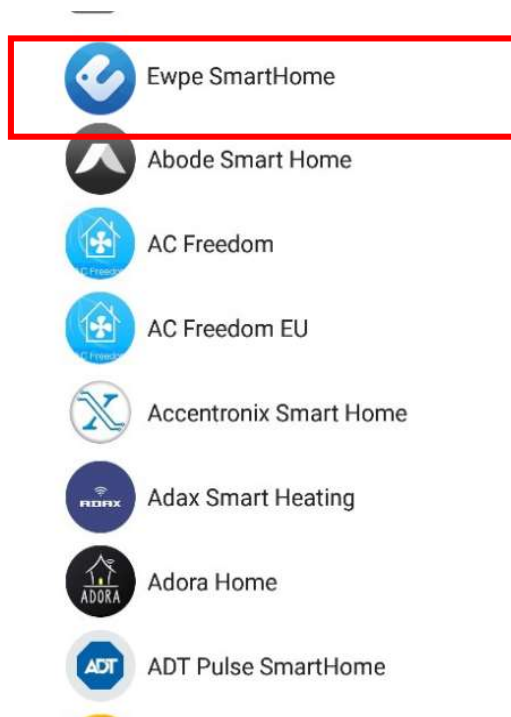

After adding, your device will appear on the device list.

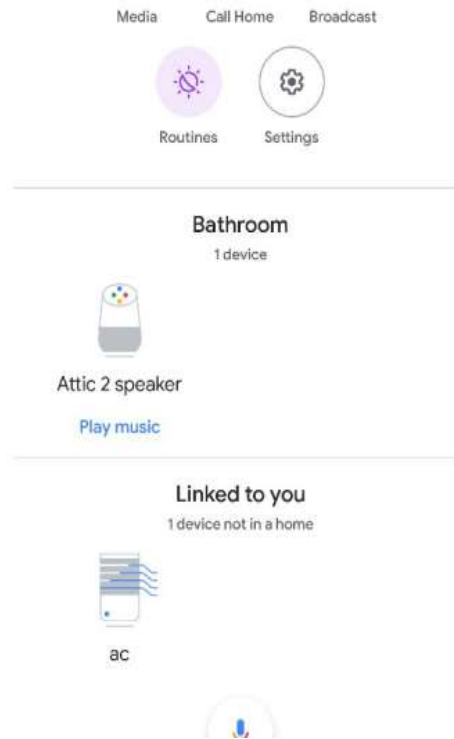

## 5. Use Google Home to control your intelligent device

Now, you can use Google Home to control your intelligent device.  
Take Air Conditioning as an example, the supporting instruction includes:

Ok Google, turn on/off Air Conditioning.

**AIR SPEED**

Ok Google, set the air conditioning to high speed.

**Mode**

Ok Google, set the AC mode to cool.

**Temperature**

Ok Google, set the temperature at 16°C.

## Emergency operation

In the event of loss or failure of the remote control, use the emergency button located under the indoor unit's front panel to turn the air conditioner on or off.

The unit will operate in automatic mode on start-up.

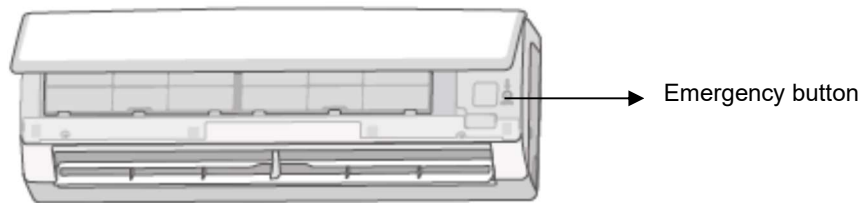

## MAINTENANCE

### Care and cleaning

**N.B.:**

**Disconnect the power before servicing or cleaning the unit.**

#### Cleaning the casing of the indoor unit

Use a soft, damp cloth to clean the outer surface of the unit.

Do not use water that is too hot, solvents, petrol or other aggressive chemical compounds, talcum powder or brushes. These may damage the colour or surface of the casing.

To remove stains, use warm water with a little neutral detergent.

Do not pour water onto the air conditioner to clean it. This may damage the internal components or cause a short circuit.

**N.B.:** Do not remove the panel when cleaning the unit.

#### Cleaning the filters

##### Open the panel

Lift the front panel of the indoor unit, as shown.

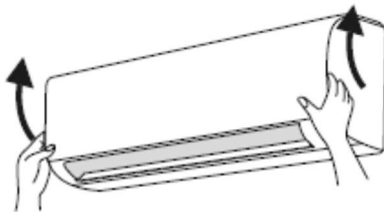

##### Remove the filters

Remove the filters by lifting one of the bottom corners and pulling them downwards, as shown.

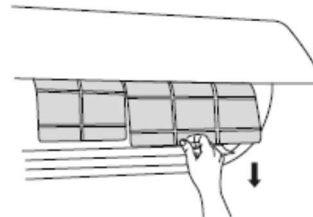

##### Clean the filters

- Use a vacuum cleaner to clean the filters.
- If they are very dirty, use water (below 45°C) and leave to dry in a cool, dark place.

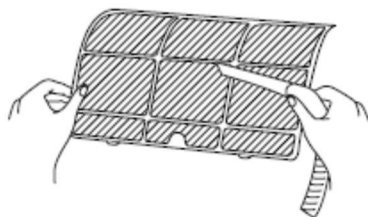

##### Refit the filters

Refit the filters and close the front panel.

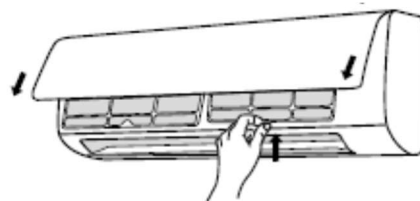

**N.B.:**

- The filters should be cleaned every three months, or more frequently if the room is very dusty.  
**WARNING!**  
**When you remove the filters, avoid contact with the heat exchanger (there is a risk of cuts or abrasion).**
- Do not use a hairdryer to dry the filters; the heat can cause damage and warping.

**Before-use checks**

1. Check that the air inlet and outlet are free of obstructions.
2. Check that the circuit breaker, plug and socket are in good working order.
3. Check that the filters are clean.
4. Check that the outdoor unit's support bracket is not damaged or corroded. If it is, contact the service centre.
5. Check that the piping is not damaged.

**After-use checks**

1. Disconnect the power supply.
2. Clean the indoor unit's panel and filters.
3. Check that the outdoor unit's support bracket is not damaged or corroded. If it is, contact the service centre.

**N.B.**

1. Many packaging materials are recyclable materials. Please dispose of them in the appropriate recycling unit.
2. If you want to remove the air conditioner, please contact your local dealer or local service provider for the correct disposal method.

**TROUBLESHOOTING****Possible faults and solutions****WARNING**

Do not attempt to repair the unit yourself. Improper repair can cause electric shocks or fire. Disconnect the unit from the power supply before contacting your local Technical Service Centre. Carry out the following checks before contacting your Technical Service Centre:

Fault	Check	Solution
<b>The indoor unit does not receive the signal from remote control or the remote control does not seem to be working</b>	Is there noticeable interference (e.g. static electricity, stable voltage)?	Pull out the plug. After about 3 minutes reinsert the plug and restart the unit.
	Is the remote control within the signal reception range?	The maximum signal reception distance is 8 m. The remote control will not work beyond this distance.
	Are there any obstacles between the remote control and the receiver?	Remove the obstacles.
	Is the remote control pointed at the receiver?	Point the remote control at the receiver on the indoor unit.
	Is the remote control's sensitivity low? Are icons blurred or missing?	Check the batteries. If the batteries are very low, replace them.
	Do icons fail to appear on the display when you operate the remote control?	Check if the remote control is damaged. If it is, replace it.
<b>No air comes out of the indoor unit</b>	Is there a fluorescent light in the room?	Position the remote control next to the indoor unit. Turn off the fluorescent light and try again.
	Is the indoor unit's air inlet or outlet blocked?	Remove the obstruction.
	In heat mode, has the indoor temperature reached the set temperature?	Once the set temperature has been reached, the indoor unit will stop blowing out air.



	Has heat mode only recently been selected?	To prevent blasts of cold air from being blown out, there will be a delay of several minutes before operation begins (this is normal).
<b>The air conditioner is not working</b>	Is there a power cut?	Wait for the power to be restored.
	Has the plug come loose?	Reinsert the plug.
	Has the circuit breaker tripped or has the fuse blown?	Have the circuit breaker or fuse replaced by a qualified technician.
	Is the wiring faulty?	Have it replaced by a qualified technician.
	Was the unit restarted immediately after shutdown?	Wait 3 minutes and then restart the unit.
	Is the setting on the remote control correct?	Reset the function.
<b>The indoor unit's air outlet produces a mist</b>	Is the indoor temperature and humidity high?	Indoor air cools rapidly. Wait for the indoor temperature and humidity to fall and the mist to disappear.
<b>The set temperature cannot be adjusted</b>	Is the unit operating in automatic mode?	The temperature cannot be adjusted in automatic mode. Change the operating mode if you want to adjust the temperature.
	Does the desired temperature fall outside the available temperature range?	The available temperature range is: 16 – 30°C.
<b>The desired level of heating/cooling cannot be achieved</b>	Is the voltage too low?	Wait for the voltage to return to normal.
	Is the filter dirty?	Clean the filter.
	Does the set temperature fall within the available temperature range?	Adjust the temperature to within the available range.
	Are there any doors or windows open?	Close any doors and windows.
<b>The unit is emitting unpleasant smells</b>	Is there an odour source (e.g. furniture, cigarettes, etc.)?	Eliminate the odour source. Clean the filter.
<b>The air conditioner turns on suddenly</b>	Are there any sources of interference (e.g. lightning, wireless devices, etc.)?	Disconnect the power supply and then reconnect it. Turn the unit on again.
<b>The outdoor unit produces steam</b>	Has heat mode been selected?	Steam production when defrosting in heat mode is a normal phenomenon.
<b>Sound of running water</b>	Has the air conditioner recently been turned on or off?	The noise is produced by the refrigerant flowing inside the unit (normal phenomenon).
<b>Creaking/cracking noises</b>	Has the air conditioner recently been turned on or off?	It is the sound of the friction caused by the expansion and/or contraction of the panel or other parts due to temperature changes.

# Analysing faults and solutions

## Error codes

In the event of a fault, the temperature indicator on the indoor unit will flash to display the corresponding error code. Refer to the following list to identify the error code.

Error code	Faults and solutions
E5	Can be eliminated by turning the unit off and on again. Otherwise, contact a qualified technician for assistance.
E6	Can be eliminated by turning the unit off and on again. Otherwise, contact a qualified technician for assistance.
U8	Can be eliminated by turning the unit off and on again. Otherwise, contact a qualified technician for assistance.
E8	Can be eliminated by turning the unit off and on again. Otherwise, contact a qualified technician for assistance.
C5	Contact a qualified technician for assistance.
F0	Contact a qualified technician for assistance.
F1	Contact a qualified technician for assistance.
F2	Contact a qualified technician for assistance.
H3	It can be eliminated switching off the unit and switching it back on. If this doesn't work contact a qualified technician to assist.
H6	It can be eliminated switching off the unit and switching it back on. If this doesn't work contact a qualified technician to assist.
E1	It can be eliminated switching off the unit and switching it back on. If this doesn't work contact a qualified technician to assist.

N.B.: In the event of other error codes, contact a qualified technician for assistance.

## Warning

If you experience any of the following problems, turn the air conditioner off and immediately disconnect the power. Then contact your local Technical Service Centre.

- The power cable is damaged or has overheated.
- The unit makes an unusual noise during operation.
- The circuit breaker keeps tripping.
- The air conditioner emits a burning smell.
- The indoor unit is leaking.
- Do not attempt to repair or reinstall the air conditioner yourself.
- If the air conditioner is operated in abnormal conditions, malfunction, electric shock or fire may result.

# INSTALLATION INSTRUCTIONS

## Installation diagrams

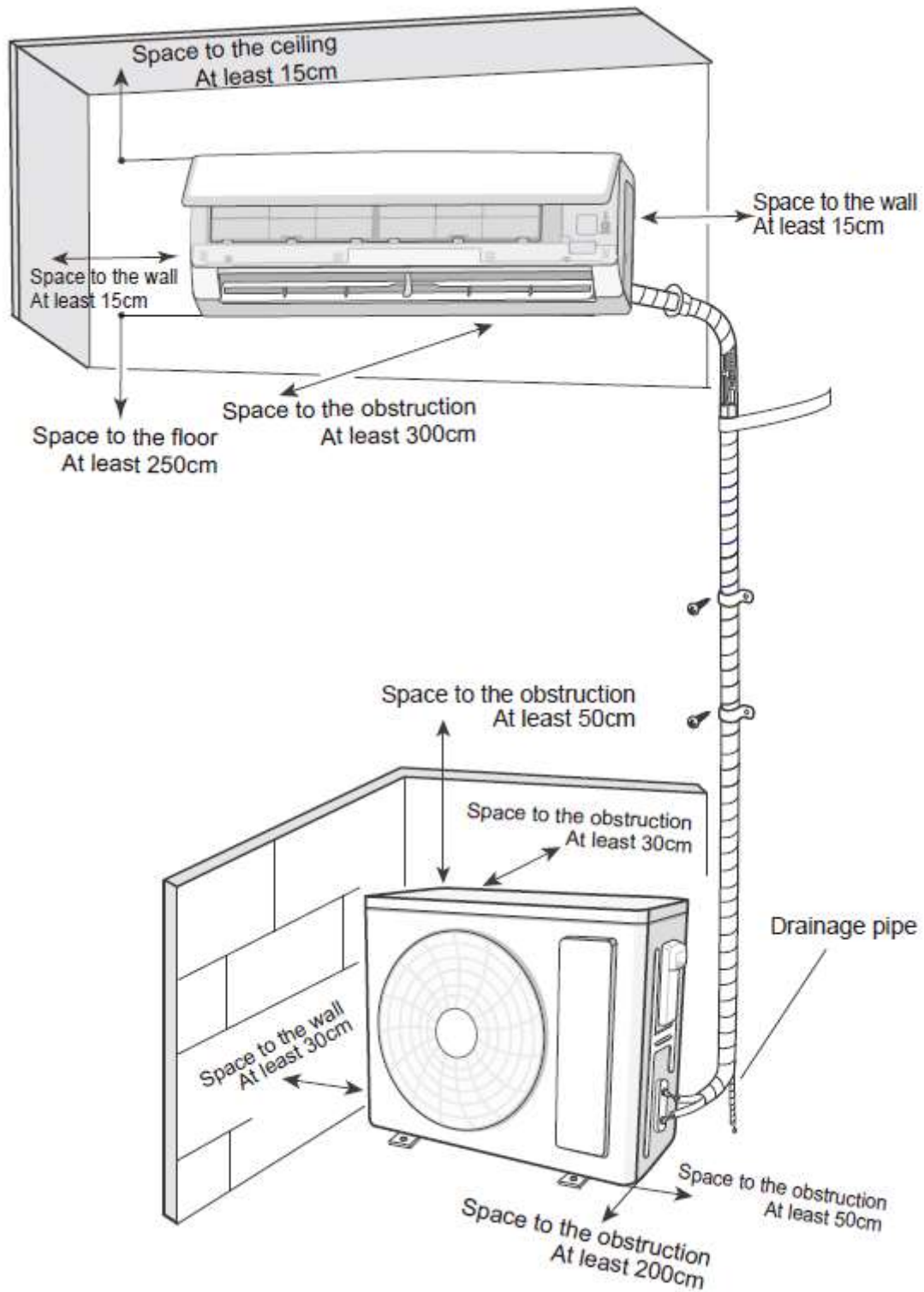

## INSTALLATION WARNINGS

**WARNING:** Make sure that the power supply is disconnected before carrying out any work on the unit.

**WARNING:** Wear appropriate personal protective equipment before carrying out any work on the unit.

**WARNING:** The appliance must be reinstalled in accordance with national system regulations.

**WARNING:** Wiring and installation must only be performed by a qualified technician trained to install, modify, extend and service the unit and perform safety and functionality tests.

**WARNING:** Install a device, master switch or electric plug that will allow all the power from the appliance to be switched off.

The following information is essential for correct unit installation. However, the installer should use his or her experience to install the unit according to specific requirements.

Do not install the unit in locations where there are flammable gases or acid or alkaline substances that may irreparably damage the copper-aluminium heat exchangers or internal plastic components.

Do not install the unit in offices or kitchens where oil vapours mixed with treated air may settle on the exchange coils, reducing performance, or on the unit's internal parts, damaging the plastic components.

**ATTENTION:** For the connection between the units, use only annealed and deoxidized copper pipe for conditioning and refrigeration and insulated with expanded polyethylene of min. 8 mm.

## Choosing a location for installation

Essential requirements	Indoor unit
<p>Do not install the unit in the following locations. Otherwise, a fault may occur.</p> <ol style="list-style-type: none"> <li>Locations with extreme heat sources or flammable or explosive gases or vapours.</li> <li>Locations with high-frequency devices (e.g. welding machines, medical equipment).</li> <li>Locations close to coastal areas.</li> <li>Locations with oils or fumes in the air.</li> <li>Locations with sulphide gas.</li> <li>Other locations that have special conditions.</li> </ol> <p>Do not operate the unit in the immediate vicinity of laundrettes, bathtubs, showers or swimming pools.</p>	<ol style="list-style-type: none"> <li>There should be no obstructions near the air inlet or outlet.</li> <li>Choose a location where the condensate can drain out easily without causing a nuisance.</li> <li>Choose a convenient location to connect the outdoor unit to the power outlet.</li> <li>Choose a location out of the reach of children.</li> <li>The site should be strong and solid enough to support the weight of the indoor unit and prevent noise or vibration.</li> <li>The unit should be installed 2.5 m from the floor.</li> <li>Do not install the indoor unit directly above electrical equipment.</li> <li>Try to keep a certain distance from fluorescent lights.</li> </ol>
Outdoor unit	<ol style="list-style-type: none"> <li>Choose a location where the noise and airflow produced by the outdoor unit will not annoy neighbours.</li> <li>The location should be well ventilated and dry; the outdoor unit must not be exposed to direct sunlight or strong winds.</li> <li>The site should be able to support the weight of the outdoor unit.</li> <li>Check that the installation complies with the requirements of the dimensional drawing for installation.</li> <li>Choose a location out of the reach of children and away from animals or plants. If this is not possible, install safety fencing.</li> </ol>

# Electrical connection requirements

## Safety precautions

1. Electrical safety standards must be met when installing the unit.
2. Use a power supply circuit and circuit breaker that comply with local safety regulations.
3. Make sure that the power supply matches the requirements of the air conditioner. An unstable power supply or incorrect wiring may result in a fault. Install suitable power cables before switching on the air conditioner.
4. Correctly connect the live, neutral and earth wires to the power outlet.
5. Disconnect the power supply before carrying out any work on the electrical circuit or carrying out any safety work. For models with a plug, make sure the plug is easily accessible after installation.
6. Do not connect the power before installation is complete.
7. Do not use the appliance if the power cable or plug are damaged. If the power cable is damaged it must be replaced by the manufacturer, retailer or other qualified person to avoid a hazard.
8. Since the temperature of the cooling circuit is high, keep the interconnecting cable away from the copper pipe.
9. The unit must be installed in accordance with national wiring regulations.
10. Installation must only be performed by trained individuals in accordance with regulations.



The unit is charged with a slightly inflammable refrigerant, R32. Improper handling of this gas may expose people and materials to serious damage. More details on this refrigerant are given at the beginning of this manual.

## Earthing

1. The air conditioner is a Class I appliance. The unit must be earthed with an appropriate device by a qualified technician. Ensure the unit is always properly earthed. Otherwise electric shock may result.
2. The green-yellow wire of the air conditioner is the earthing wire and may not be used for other purposes.
3. The earth resistance must meet national standards for electrical safety.
4. The unit must be positioned so that the plug is accessible.
5. An all-pole isolating switch with a minimum contact gap of 3mm in each pole must be connected to the fixed cable.

# INSTALLATION

## Indoor unit installation

### Step one: choose of the position

Decide where to install the unit based on room design, architectural limitations and customer requirements. Check that in the selected location the unit can be accessed for servicing and cleaning the filters. To install, use the installation plate as a template to identify the exact position for the wall plugs and through-hole in the wall. The plastic casing has stoppers which if necessary can be removed to route the refrigerant lines and cables. When operating in cool or dry mode, the moisture in the air condenses on the coil of the indoor unit, collects in the basin and drains out through the special rubber hose. The hose must be connected to a pipe with a suitable gradient, ensuring no unnecessary bends are created. Do not run siphons and do not immerse in water.

### Step two: mount the wall-installation plate

1. Position the installation plate on the wall. Use a level to position it horizontally and mark the holes for the bolts on the wall.
2. Drill the holes for the screws in the wall with a hammer drill (the drill bit must match the plastic wall plug). Then insert the wall plugs into the holes.
3. Secure the plate to the wall with the self-tapping screws (ST4.2X25TA). Check it is securely attached by pulling on the bracket. If a plastic wall plug is loose, drill another hole nearby with the hammer drill.

### Step three: drill the hole for the piping

Select the position for the piping hole according to the direction of the outlet pipe. The piping hole must be slightly lower than the wall-installation frame, as shown below.

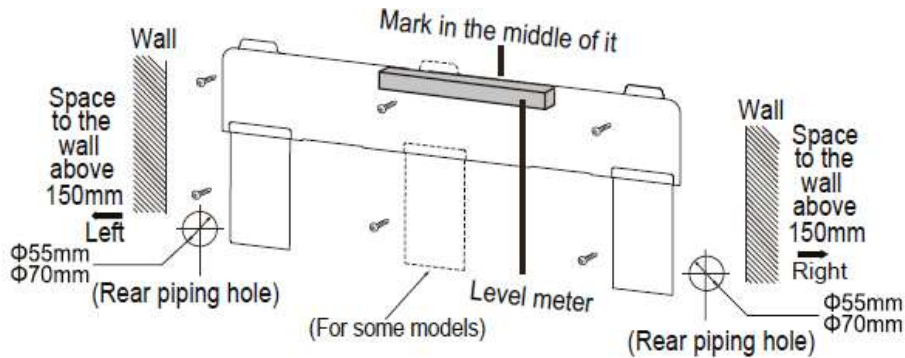

Drill a piping hole of diameter  $\Phi 55$  at the chosen location for the outlet pipe. To allow for proper drainage, the piping hole in the wall must slant slightly downwards to the outdoor side, with a gradient of  $5 - 10^\circ$ .

#### N.B.:

- Take the necessary safety measures when drilling the hole and do not allow dust to enter.
- The plastic wall plugs are not supplied but must be purchased on site.

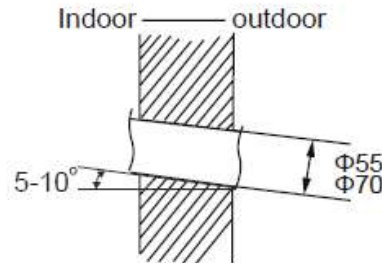

### Step four: outlet pipe

The pipe can be brought out in various different directions: right, rear right, left or rear left.

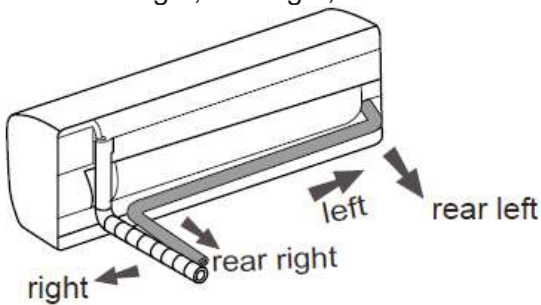

Once you have selected the direction of the outlet (left or right), drill the corresponding hole at the bottom.

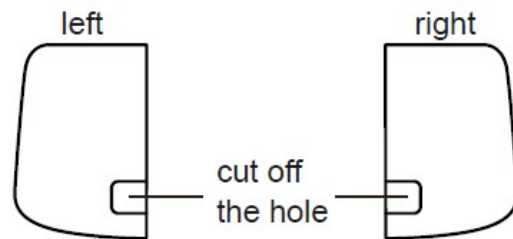

### Step five: connect the indoor unit pipe

1. Position the pipe joint in the corresponding bellmouth.
2. Pre-tighten the union nut by hand.
3. Adjust the torque according to the following table. Position the open-end spanner on the pipe joint and position the torque wrench on the union nut. Tighten the nut with the wrench.

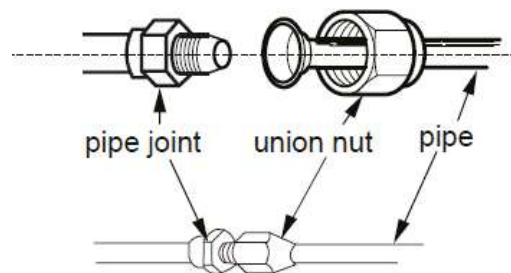

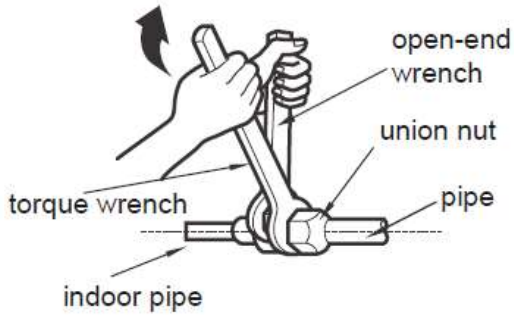

Hex nut diameter	Tightening torque (Nm)
$\Phi 6.35$	15 – 20
$\Phi 9.52$	30 – 40
$\Phi 12.7$	45 – 55
$\Phi 15.88$	60 – 65

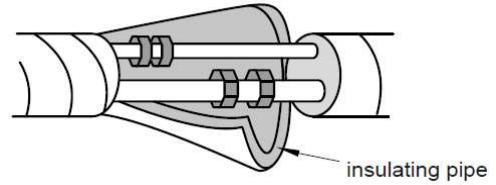

Wrap the indoor pipe and the joint of the connecting pipe with an insulating tube. Then wrap with tape.

### Step six: install the condensate drain pipe

1. Connect the drain pipe to the outlet pipe of the indoor unit.
2. Bind the joint with tape.

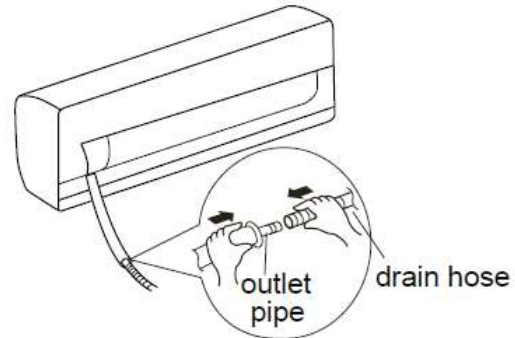
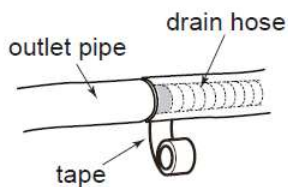

N.B.:

- Add an insulating tube to the indoor drain pipe to prevent condensation.
- The plastic wall plugs are not supplied.

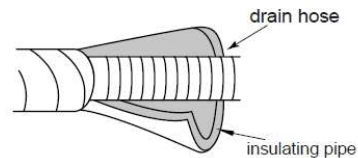

### Step seven: connect the indoor unit electrical cable

1. Open the panel. Remove the screw that secures the small panel covering the terminal board.
2. Insert the indoor and outdoor unit connecting cable into the rear hole corresponding to the terminal block. Then pull it out of the front.
3. Remove the cable clip. Connect the power cable to the terminal block according to colour. Tighten the screw and secure the power cable with the clip.

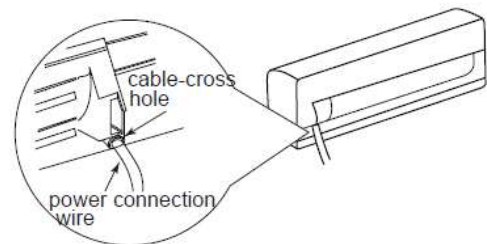
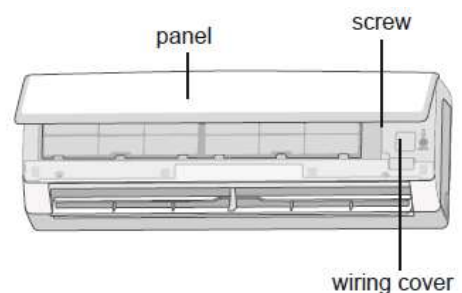

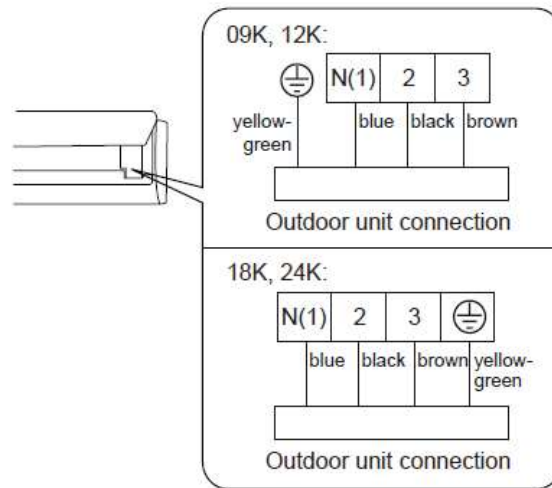

Note: the link card is only for reference, please take into consideration the actual one.

4. Reposition the terminal block cover and tighten the screws.
5. Close the panel.

**N.B.:**

- All wiring must be connected as shown on the unit's wiring diagram. All indoor and outdoor unit cables must be connected by a qualified technician.
- If the power cable is not long enough, contact the supplier for a new one. Do not attempt to extend it yourself.
- For air conditioners equipped with a plug, the plug must be easily accessible upon completion of installation.
- For air conditioners without a plug, install a circuit breaker on the line. The circuit breaker must be single-pole and the contact gap must be greater than 3mm.

**Step eight: bind the pipes**

1. Bind together the connecting pipe, the power cable and the drain pipe with binding tape.

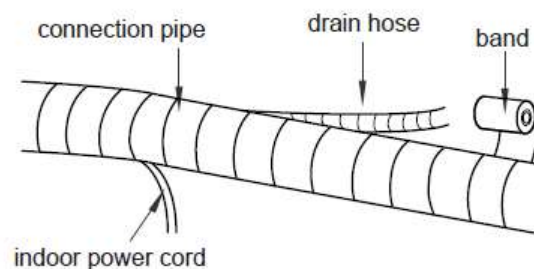
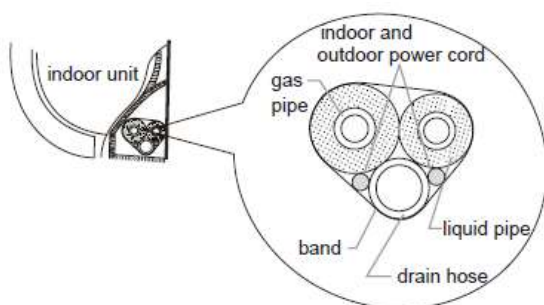

3. Bind them evenly.
4. The liquid pipe and gas pipe must be bound separately at the end.

2. Reserve a section of the drain pipe and power cable for installation when binding. When you have bound up to a certain point, separate the indoor power cable and then the drain pipe.

**N.B.:**

**The power cable and signal control cable must not be rolled or coiled.**  
**The drain pipe must be bound at the bottom.**



### Step nine: hang the indoor unit

1. Insert the bound pipes into the wall pipe and route them through the hole in the wall.
2. Hang the indoor unit on the wall-installation plate.
3. Fill the gap between the pipes and the hole in the wall with sealant.
4. Secure the wall pipe.
5. Check that the indoor unit is securely installed and flush against the wall.

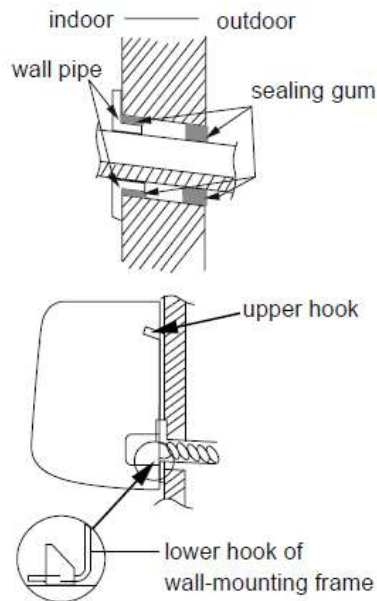

N.B.:

- Avoid bending the drain pipe too much in order to prevent clogging.

## Outdoor unit installation

### Step one: secure the outdoor unit support

1. Choose a location for the unit according to the structure of the house.
2. Use expansion screws to secure the outdoor unit support in the chosen position.

N.B.:

- Take the appropriate safety measures when installing the outdoor unit.
- Make sure that the bracket can support at least four times the weight of the unit.
- The outdoor unit must be connected at least 3 cm above the ground in order to install the drain joint.
- Units with a cooling capacity of 2300 W – 5000 W require 6 expansion screws; units with a cooling capacity of 6000 W – 8000 W require 8 expansion screws; units with a cooling capacity of 10000 W – 16000 W require 10 expansion screws.

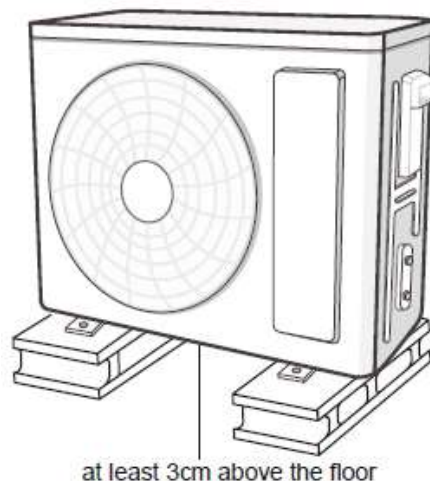

### Step two: install the drain joint

1. Connect the outdoor drain joint into the hole on the chassis, as shown below.
2. Connect the drain hose into the drain hole.

### Step three: secure the outdoor unit

1. Position the outdoor unit on the support.
2. Secure the foot holes of the outdoor unit with bolts.

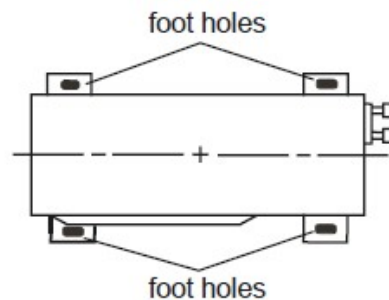
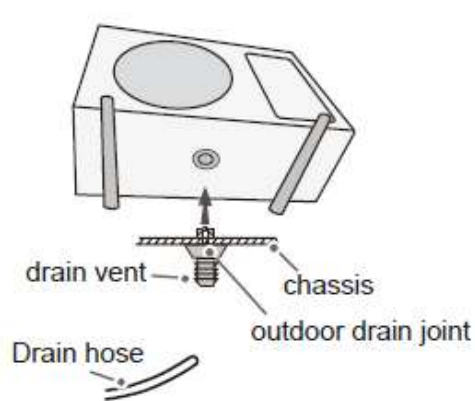

### Step four: connect the indoor and outdoor pipes

1. Remove the screw on the right-hand handle of the outdoor unit and remove the handle.
3. Pre-tighten the union nut by hand.

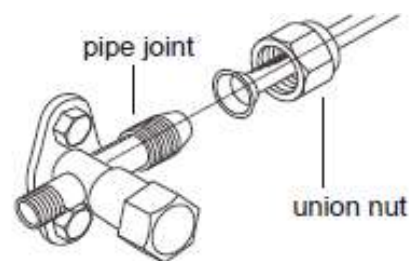
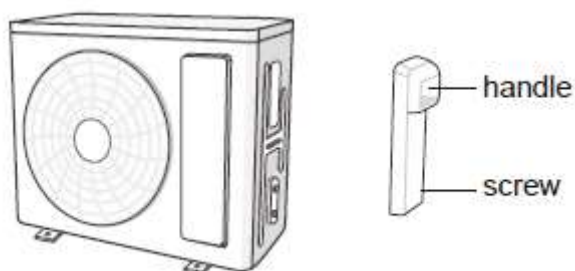

2. Remove the screw cap of the valve and position the pipe joint in the bellmouth of the pipe.
4. Tighten the union nut with the wrench according to the following table.

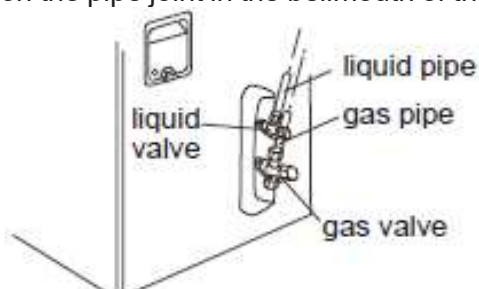

Hex nut diameter	Tightening torque (Nm)
Φ6.35	15 – 20
Φ9.52	30 – 40
Φ12.7	45 – 55
Φ15.88	60 – 65

### Step five: connect the outdoor electrical cable

1. Remove the wire clip. Connect the power cable and the signal control cable (only for cooling and heating units) to the wiring terminal according to colour. Secure them with the screws.

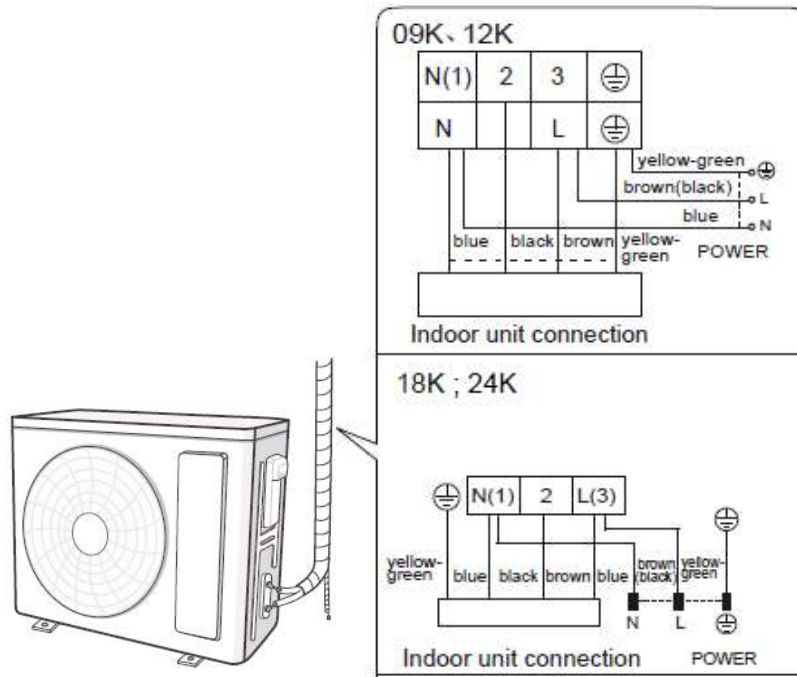

2. Secure the power cable and the signal control cable with the clip (only for cooling and heating units).

- N.B.: • Once you have tightened the screw, pull on the power cable gently to check it is secure.  
 • Never cut the power cable to extend or reduce the distance.

**Step six: tidy up the pipes**

1. The pipes should be routed along the wall, bent only as much as is necessary and, if possible, hidden from view. Minimum pipe bending radius: 10 cm.
2. If the outdoor unit is higher than the hole in the wall, you must create a U-bend in the pipe before it enters the room to prevent rain from getting into the room.

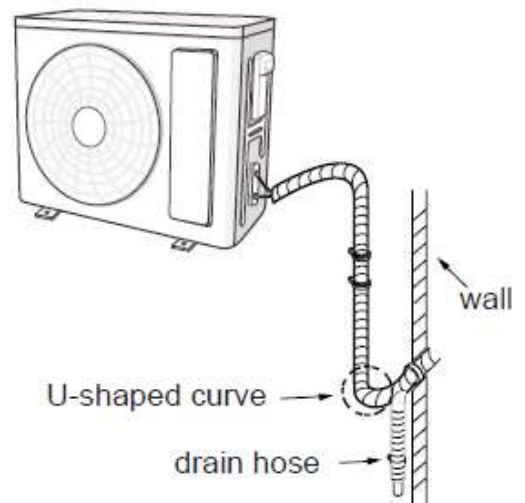

## NOTICE

- The through-wall height of drain hose should not be higher than the outlet pipe hole of indoor unit.

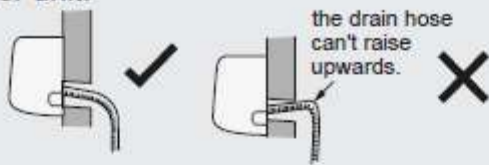

- The water outlet can't be placed in water in order to drain smoothly.

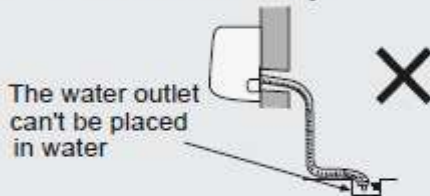

- Slant the drain hose slightly downwards. The drain hose can't be curved, raised and fluctuant, etc.



- The drain hose can't be fluctuant



## Vacuum pump

### Using the vacuum pump

- Remove the valve caps of the liquid valve and gas valve and remove the nut of the refrigerant charge port.
- Connect the piezometer charge pipe to the refrigerant charge bore of the gas valve. Then connect the other charge pipe to the vacuum pump.
- Open the piezometer completely and let it run for 10 – 15 minutes to check if the pressure of the piezometer remains at -0.1 MPa.
- Close the vacuum pump and maintain this condition for 1 – 2 minutes to check if the pressure of the piezometer remains at -0.1 MPa. If the pressure falls, there may be a leak.

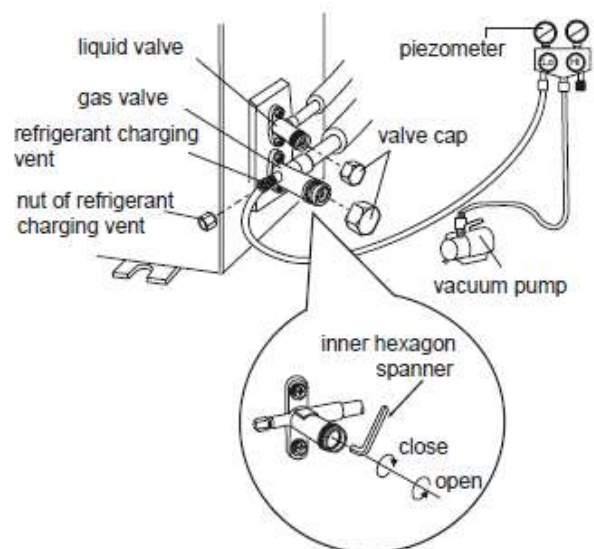

- Remove the piezometer. Fully open the plunger of the liquid valve and gas valve with the inner hex key.
- Tighten the screw caps of the valves and refrigerant charge port.
- Reinstall the handle.

### Leak detection

Check for leaks using a leak detector. If you do not have a leak detector you can use soapy water.

## Post-installation checks

Checks	Possible fault
Has the unit been installed securely?	The unit could fall, move or produce excessive noise.
Has the leakage test of the refrigerant been done?	Risk of condensation and dripping water.
Is the thermal insulation of the pipes sufficient?	Risk of condensation and dripping water.
Does the water drain properly?	Risk of condensation and dripping water.
Does the supply voltage match the voltage indicated on the data plate?	Risk of malfunction or damage to components.
Have the piping and electrical wiring been installed correctly?	Risk of malfunction or damage to components.
Has the unit been properly earthed?	Risk of electric leakage.
Does the power cable meet requirements?	Risk of malfunction or damage to components.
Are there any obstructions at the air inlet or outlet?	The cooling (heating) capacity may be insufficient.
Have the dust and other particles produced during installation been removed?	Risk of malfunction or damage to components.
Are the gas valve and liquid valve of the connecting tube fully open?	The cooling (heating) capacity may be insufficient.
The entrance and exit of the pipe holes have been covered?	Risk of condensation and dripping water.

## TESTING AND OPERATION

### Functional testing

Connect the power and press the ON/OFF button on the remote control to start operation.

Press the MODE button to select AUTO, COOL, DRY, FAN and HEAT mode and check the air conditioner operates normally.

If the ambient temperature is below 16°C, the air conditioner will be unable to start cooling.

# APPENDICES

## Piping configuration

1. Standard connecting tube length: 5 m.
2. Minimum connecting tube length: 3 m.
3. Maximum connecting tube length and maximum height difference:

Capacity	Maximum connecting tube length	Maximum height difference
9000 Btu/h	15	10
12000 Btu/h	20	10
18000Btu/h	25	10
24000Btu/h	25	10

**Warning! Note the additional charge on the data plate affixed to the outdoor unit.**

Additional oil and refrigerant charging

- If the length of the connecting pipe is increased by 10 m compared to the standard length, add 5 ml of refrigeration oil for every 5 m of pipe added.
- Method for calculating the amount of additional refrigerant charge (liquid pipe): amount of additional refrigerant charge = additional length of liquid pipe x additional amount of refrigerant charge per metre.

Connecting pipe diameter		Additional refrigerant
Liquid pipe (mm)	Gas pipe (mm)	(g/m)
Φ <sub>6,35</sub>	Φ <sub>9,52</sub>	16 (9-12-18K)
Φ <sub>6,35</sub>	Φ <sub>12,7</sub>	16 (24K)

## Safety operation of flammable refrigerant

### Qualification requirement for installation and maintenance

- All workers who engage with the refrigeration system should bear the valid certification awarded by the authoritative organization, and the qualification recognized by the industry for dealing with the refrigeration system.
- The refrigeration system can only be repaired following the methods suggested by the equipment's manufacturer.

### Installation notes

- The air conditioner mustn't be used in a room that has running fire or heat sources (such as, working coal gas ware, operating heater).
- Do not drill holes in the circuit or burn the connection pipe.
- The air conditioner must be installed in a room that is larger than the minimum room area. The minimum room area is shown on the following "table a".
- Leak test is mandatory after installation.

table a - Minimum room area ( m <sup>2</sup> )

Minimum room area( m <sup>2</sup> )	Charge amount (kg)	≤1.2	1.3	1.4	1.5	1.6	1.7	1.8	1.9	2	2.1	2.2	2.3	2.4	2.5
	floor location	/	14.5	16.8	19.3	22	24.8	27.8	31	34.3	37.8	41.5	45.4	49.4	53.6
	window mounted	/	5.2	6.1	7	7.9	8.9	10	11.2	12.4	13.6	15	16.3	17.8	19.3
	wall mounted	/	1.6	1.9	2.1	2.4	2.8	3.1	3.4	3.8	4.2	4.6	5	5.5	6
	ceiling mounted	/	1.1	1.3	1.4	1.6	1.8	2.1	2.3	2.6	2.8	3.1	3.4	3.7	4

## Maintenance notes

- Check whether the maintenance area or the room area meet the requirement of “table a”- the unit is only allowed to be operated in rooms that meet these requirements.
- Check whether the maintenance area is well-ventilated. - The continuous ventilation status should be kept during the entire operation process.
- Check whether there is a fire source or potential fire source in the maintenance area. Running fire is prohibited in the maintenance area and the “no smoking” sign should be hanged.
- Check whether the warning sign is in good condition, otherwise replace it.

## Welding

- If it is necessary to cut or weld the refrigerant system pipes in the maintenance procedures, please follow the steps here below:
  - a. Shut down the unit and cut power supply
  - b. Eliminate the refrigerant
  - c. Vacuum with a vacuum machine
  - d. Clean the pipes with the N2 gas
  - e. Cut and weld or
  - f. Bring the unit to a service centre for welding
- The refrigerant should be recycled in a specialized storage tank.
- Make sure there aren't any free flames near the outlet of the vacuum pump and that it's well-ventilated.

## Filling the refrigerator circuit

- Use refrigerant filling appliances specialized for R32. Make sure that different kinds of refrigerant don't contaminate one another.
- The refrigerant tank should be kept upright when filling with the refrigerant.
- Stick the label on the system after filling is finished.
- Don't overfill.
- After filling is finished, please test the unit for leakage detection before the operation test; another test for leakage detection should be carried out when the refrigerant is removed.

## Safety instructions for transportation and storage

- Please use a flammable gas detector to check before unloading and opening the container.
- No fire source and no-smoking.
- According to the local rules and laws

# Procedure for extending the piping

**N.B.:**

Improper extension of piping is the main cause of refrigerant leaks. Proceed as shown below:

**1. Cut the pipe**

- Check the length of the pipe based on the distance between the indoor unit and outdoor unit.
- Cut the required pipe using a pipe cutter.

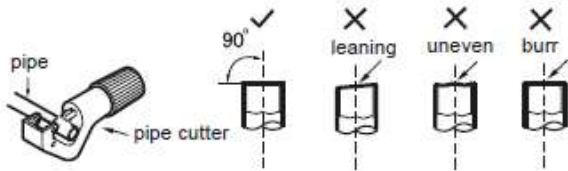

**5. Expand the port**

Expand the port using a pipe expander.

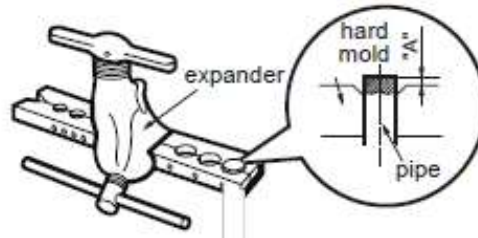

**2. Remove burrs**

- Remove burrs with a file, ensuring they do not go into the pipe.



**N.B.:**

- "A" varies according to diameter:

Outdoor diameter (mm)	A (mm)	
	Max.	Min.
6.35 (1/4")	1.3	0.7
9.52 (3/8")	1.6	1.0
12.7 (1/2")	1.8	1.0
15.88 (5/8")	2.4	2.2

**3. Secure an insulating tube**

**4. Install a union nut**

- Remove the union nut on the indoor connecting pipe and outdoor valve. Install the union nut on the pipe.

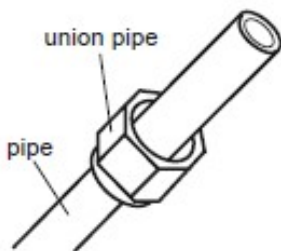

**6. Inspection**

Check the quality of the expanded port. If defective, expand the port again following the procedure described above.

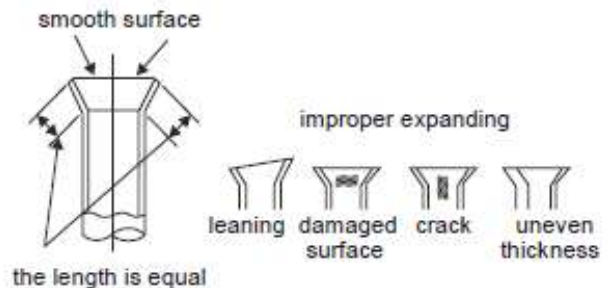



## Warnings for the refrigeration system specialist

Here are warnings and safety instructions for the maintenance of systems containing flammable refrigerant (repairs should only be carried out by specialists).

a) Any person involved in the work or in the interruption of a refrigeration circuit must be equipped with PEF (European Refrigerators License) as required by the D.P.R. n. 146/2018 implementing Regulation (EU) no. 517/2014.

b) Maintenance should only be performed as recommended by the equipment manufacturer. Maintenance and repairs that require the assistance of other qualified personnel must be performed under the supervision of the person competent in the use of flammable refrigerants.

Before starting work on systems containing flammable refrigerants, safety checks are required to ensure that the risk of ignition is minimized.

c) Checks to be carried out on systems that use flammable refrigerants:

- the charge must be proportionate to the size of the room in which the units containing refrigerant are installed;
- units and ventilation openings must function properly and are not obstructed;
- if an indirect refrigerant circuit is used, the secondary circuit must be checked for the presence of refrigerant;
- the marking on the equipment must be visible and indelible. Illegible markings and signs must be corrected;
- refrigerant piping or components must be installed in a location where they are unlikely to be exposed to any substance that can corrode the component-containing refrigerant, unless the components are constructed from materials that are inherently resistant to corrosion or are adequately protected against corrosion.

d) Checks on electrical devices

Repair and maintenance of electrical components must include initial safety checks and component inspection procedures. If there is a fault that could compromise safety, do not connect the power supply to the circuit until it is satisfactorily resolved. If the fault cannot be remedied immediately, but operation must continue, a suitable interim solution must be used. This must be reported to the owner of the equipment so that all parties are informed.

Initial security checks include:

- Check that the capacitors are discharged: this must be done safely to avoid the risk of sparks;
- Verify that no electrical components and wiring are exposed while charging, restoring or draining the system;
- Check that there is ground continuity.

e) Check for refrigerant leaks

The area should be checked with an appropriate refrigerant detector before and during work, to ensure that the technician is aware of potentially toxic or flammable atmospheres. Make sure that the leak detection equipment in use is suitable for use with all applicable refrigerants, i.e. non-sparking, properly sealed or intrinsically safe.

Check for R32 refrigerant leaks

Note: Check for refrigerant leakage in an environment where there are no potential sources of ignition. No halogen probe (or any other detector that uses an open flame) should be used.

Leak Detection Method:

For systems with R32 refrigerant, an electronic leak detection tool is available to detect and leak detection should not be conducted in a refrigerant environment. Make sure the leak detector does not become a potential source of ignition and is applicable to the measured refrigerant. The leak detector must be set for the minimum flammable fuel concentration (percentage) of the refrigerant. Calibrate and adjust to the correct gas concentration (no more than 25%) with the refrigerant used.

The fluid used in leak detection is applicable to most refrigerants. But do not use chloride based solvents to prevent the reaction between chlorine and refrigerants and corrosion of copper piping.

If you suspect a leak, remove all fire from the scene or put out the fire.

If the location of the leak is to be welded, then all refrigerants must be recovered or isolate all refrigerants away from the leak site (using the shut-off valve). Before and during soldering, use OFN to purify the entire system.

f) Presence of fire extinguisher

If hot work is to be performed on the refrigeration equipment or any associated part, adequate fire fighting equipment must be available. It is necessary to have a dry powder or CO<sub>2</sub> extinguisher adjacent to the charging area.

g) Ventilated area

Make sure the area is outdoors or is adequately ventilated before breaking into the system or performing any hot work. Continuous ventilation must be present during the period in which the work is being carried out. Ventilation should safely disperse the released refrigerant and preferably expel it to the atmosphere.

h) Controls on refrigeration equipment

When replacing electrical components, they must be fit for purpose and with the correct specifications. The manufacturer's maintenance and service guidelines should always be followed. If in doubt, consult the manufacturer's technical department for assistance.

i) Repairs on sealed components

During repairs to sealed components, all electrical supplies must be disconnected from the equipment being worked on before removing the sealed covers, etc.

If it is absolutely necessary to have an electrical power supply to the equipment during maintenance, then a leak detection device must be placed at the most critical point to warn of a potentially dangerous situation.

Particular attention must be paid to the following to ensure that, by working on the electrical components, the casing is not altered in such a way as to compromise the level of protection. This includes damage to cables, excessive number of connections, terminals not made to original specifications, damage to gaskets, incorrect assembly of cable glands, etc.

- Make sure the appliance is mounted securely.
- Ensure that gaskets or sealing materials are not degraded to the point that they no longer serve the purpose of preventing the entry of flammable atmospheres. Replacement parts must conform to the manufacturer's specifications.

NOTE: The use of silicone sealant can inhibit the effectiveness of some types of leak detection equipment. Intrinsically safe components do not need to be isolated before working on them.

l) Repair of intrinsically safe components

Do not apply permanent inductive or capacitive loads to the circuit without ensuring that it does not exceed the voltage and current allowed for the equipment in use.

The intrinsically safe components are the only ones that can be worked on in the presence of a flammable atmosphere. The test equipment must be of the correct evaluation.

Replace components only with parts specified by the manufacturer. Other parts can cause the refrigerant to ignite in the atmosphere due to a leak.

j) Wiring

Verify that the wiring is not subject to wear, corrosion, excessive pressure, vibration, sharp edges, or other adverse environmental effects.

The control must also take into account the effects of aging or continuous vibrations from sources such as compressors or fans.

k) Deactivation

Before carrying out this procedure, it is essential that the technician is fully familiar with the equipment and all its details. Good practice is recommended that all refrigerants be recovered safely. Before the task is performed, a sample of the oil and refrigerant must be taken in case an analysis is required before reuse of the recovered refrigerant. It is essential that electricity is available before the start of the activity.

A. Become familiar with the equipment and its operation.

- B. Electrically isolate the system.
- C. Before attempting the procedure, make sure that:
  - mechanical handling equipment is available, if required, for handling the refrigerant cylinders;
  - all personal protective equipment is available and used correctly;
  - the recovery process is supervised at all times by a competent person;
  - Recovery equipment and cylinders comply with appropriate standards.
- D. If possible, drain the refrigerant system.
- E. If vacuum is not possible, make a manifold so that the refrigerant can be removed from the various parts of the system.
- F. Make sure the cylinder is placed on the scale before recovery takes place.
- G. Start the recovery machine and operate according to the manufacturer's instructions
- H. Do not overfill the cylinders. (Not more than 80% by volume of liquid charge).
- I. Do not exceed, even temporarily, the maximum working pressure of the cylinder.
- J. When the cylinders have been filled correctly and the process is complete, ensure that the cylinders and equipment are promptly removed from the site and that all isolation valves on the equipment are closed.
- K. Recovered refrigerant should not be charged to another refrigeration system unless it has been cleaned and checked.

#### I) Labeling

The equipment must be labeled indicating that it has been shut down and drained of refrigerant. The label must be dated and signed. For appliances containing flammable refrigerants, make sure there are labels on the appliance indicating that the appliance contains flammable refrigerant.

#### Recovery

When removing refrigerant from a system, whether for maintenance or decommissioning,

It is recommended that all refrigerants be removed safely.

When transferring refrigerant to cylinders, ensure that only appropriate refrigerant recovery cylinders are used. Make sure the correct number of cylinders are available to maintain full system charge. All cylinders to be used are designated for the recovered refrigerant and labeled for that refrigerant (i.e. special cylinders for recovering refrigerant). The cylinders must be complete with pressure relief valve and relative shut-off valves in good working order. Empty recovery cylinders are evacuated and, if possible, cooled before recovery takes place.

If compressors or compressor oils need to be removed, make sure they have been evacuated to an acceptable level to ensure that flammable refrigerant does not remain within the lubricant. The evacuation process must be carried out before returning the compressor to suppliers. To speed up this process, only electrical heating of the compressor body must be used. When oil is drained from a system, it must be done safely

#### Work procedure

The work must be carried out according to a controlled procedure in order to minimize the risk of the presence of flammable gas or vapor during the execution of the work.

##### 2. General work area

All maintenance personnel and others working in the local area should be educated on the nature of the work being performed. Work in confined spaces must be avoided. The area around the work area must be sectioned. Ensure that conditions within the area have been secured by the control of flammable material.

##### 3. No ignition sources

No person carrying out work in relation to a refrigeration system involving exposure to piping must use sources of ignition in a way that creates the risk of fire or explosion. All possible sources of ignition, including cigarette smoke, must be kept sufficiently far from the place of installation, repair, removal and disposal, during which the refrigerant may possibly be released into the surrounding space. Before starting work, the area around the equipment must be checked to ensure that there is no risk of flammability or ignition hazards. "No smoking" signs must be displayed.

## Removal and evacuation

When breaking into the refrigerant circuit to make repairs or for any other purpose, conventional procedures must be used. However, for flammable refrigerants it is important to follow the best procedures as there is a risk of flammability.

The following procedure must be followed:

- remove the refrigerant;
- purge the circuit with inert gas; evacuate;
- purge again with inert gas;
- open the circuit by cutting or brazing.

The refrigerant charge must be recovered in the correct recovery cylinders.

For appliances containing flammable refrigerants, the system must be flushed with OFN to make the unit safe. You may need to repeat this process several times. Compressed air or oxygen must not be used for purging refrigerant systems.

For appliances containing flammable refrigerants, flushing must be achieved by breaking the vacuum in the system with OFN and continuing to fill until the operating pressure is reached, then discharging to the atmosphere and finally lowering the vacuum. This process must be repeated until there is no more refrigerant in the system. When the final OFN charge is used, the system must be vented to atmospheric pressure to allow the work to be carried out. This operation is absolutely essential if you want to carry out brazing operations on the pipes.

Make sure that the vacuum pump outlet is not close to ignition sources and that ventilation is available.

## Charging procedures

In addition to conventional charging procedures, the following requirements must be followed.

- Make sure that contamination of different refrigerants does not occur when using charging equipment. Hoses or lines should be as short as possible to minimize the amount of refrigerant they contain.
- The cylinders must be kept upright.
- Make sure the refrigeration system is grounded before charging the system with refrigerant.
- Label the system when charging is complete (if not already done).
- Be very careful not to overfill the refrigeration system.

Before recharging the system, it must be pressure tested with the appropriate purge gas.

The system must undergo a leak test upon completion of the charge but prior to commissioning. A subsequent leak test must be carried out before leaving the site.

**REGULATION (EU) No. 517/2014 - F-GAS**

The unit contains R32, a fluorinated greenhouse gas with global warming potential (GWP) = 675.  
Do not release R32 into the atmosphere.

**ECOLIGHT PLUS 9000 UE - Kg. 0,5 = 0,337 Tonn CO<sub>2</sub> equiv.**

**ECOLIGHT PLUS 12000 UE - Kg. 0,55 = 0,371 Tonn CO<sub>2</sub> equiv.**

**ECOLIGHT PLUS 18000 UE - Kg. 0,75 = 0,506 Tonn CO<sub>2</sub> equiv.**

**ECOLIGHT PLUS 24000 UE - Kg. 1,3 = 0,878 Tonn CO<sub>2</sub> equiv.**



improve your life

[www.argoclima.com](http://www.argoclima.com)